

CATALISTINO 2023
CATALOGUE-PRICE LIST . CATALOGUE-LISTE DES PRIX

HAFRO

CERAMICHE DI HAFRO

GRUPPO GEROMIN
VENEZIA 1945

HAFRO
WELLNESS & SHOWER



Le porcellane sanitarie di Hafro sono il completamento del nostro progetto di Total Living Bathroom. Quattro collezioni disegnate per distinguersi attraverso l'equilibrio dell'eleganza dello stile italiano. Una proposta totale, sempre coordinata, ed in costante evoluzione per precedere il mercato con oggetti positivi, attraenti che devono accompagnarci nel lungo periodo.

Hafro's sanitaryware porcelain are the completion of our Total Living Bathroom project. Four collections designed to stand out through the balance of the elegance of Italian style. A complete and coordinated range of products that are in constant evolution to precede the market with positive, attractive objects that are meant to accompany us in the future.

Les produits sanitaires en porcelaine de Hafro sont l'achèvement de notre projet Total Living Bathroom. Quatre collections conçues pour se distinguer à travers l'équilibre de l'élégance du style italien. Une proposition globale, toujours coordonnée et en constante évolution pour devancer le marché avec des objets positifs et attrayants qui doivent nous accompagner à long terme.

Carlo Geromin

Amministratore Delegato
Gruppo Geromin

New collection

Le nuove collezioni: sanitari sospesi e a terra.

The new collections: wall and ground-installed sanitaryware.
Les nouvelles collections: sanitaires suspendus et au sol.

Avigo

Fio

Stino

Voga

Collezione **Avigo**



Pag. 26



Vasi e Bidet sospesi
Wall-hung WCs and Bidets - WC et Bidets suspendus



Vasi e Bidet a terra
Ground-installed WCs and Bidets - WC et Bidets au sol

Collezione **Fio**



Pag. 46



Vasi e Bidet sospesi
Wall-hung WCs and Bidets - WC et Bidets suspendus



Vasi e Bidet a terra
Ground-installed WCs and Bidets - WC et Bidets au sol

Collezione **Stino**



Pag. 64



Vasi e Bidet sospesi
Wall-hung WCs and Bidets - WC et Bidets suspendus



Vasi e Bidet a terra
Ground-installed WCs and Bidets - WC et Bidets au sol

Collezione **Voga**



Pag. 72



Vasi e Bidet sospesi
Wall-hung WCs and Bidets - WC et Bidets suspendus

Lavabi d'arredo

Design washbasins - Lavabos d'ameublement

Lavabo **Avigo**



Pag. 34



Lavabo da appoggio
Countertop washbasin - Lavabo à poser sur plan

Lavabo **Albo**



Pag. 50



Lavabo da appoggio
Countertop washbasin - Lavabo à poser sur plan

Lavabo **Altino**



Pag. 78



Lavabo da appoggio
Countertop washbasin - Lavabo à poser sur plan

Vasche freestanding

Freestanding bathtubs - Baignoires îlot

Vasca **Avigo**



Pag. 40



Vasca freestanding
Freestanding bathtubs - Baignoires autoportantes

Vasca **Fio**



Pag. 58



Vasca freestanding
Freestanding bathtubs - Baignoires autoportantes

Lavabo **Arko**



Pag. 82

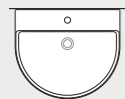

Lavabo da appoggio e parete
Countertop and wall-hung washbasin
Lavabo à poser sur plan et au mur

Lavabo **Vigno**



Pag. 88



Lavabo freestanding e a parete
Freestanding and wall-hung washbasin
Lavabo autoportante et au mur

Consolle **Vera**



Pag. 102

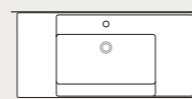

Consolle Vera L 72-92-107-121-141 cm
Vera Console - Console Vera

Tecnologia per il benessere

Technology for wellbeing - Technologie pour le bien-être

Design avanguardistico, finiture speciali innovative e funzionalità idrauliche rivoluzionarie: Gruppo Geromin è pioniere delle evoluzioni nel settore del benessere e mette la tecnologia produttiva al servizio delle persone e del vivere in equilibrio e armonia. Questa attitudine al lavoro si traduce in prodotti eccellenti, progettati e costruiti per durare, anche nel settore delle ceramiche sanitarie.

Cutting-edge design, innovative special finishes and revolutionary plumbing functions: Gruppo Geromin is a pioneer of evolution in the wellness sector, putting production technology at people's service and at the service of a balanced and harmonious life. This working attitude is reflected in excellent products, designed and built to be long-lasting, even in the bathroom ceramics sector.

Design d'avant-garde, finitions spéciales innovantes et fonctions sanitaires révolutionnaires: le Geromin Group est un pionnier du développement dans le secteur du bien-être et met la technologie de production au service des personnes et du vivre en harmonie et en équilibre. Cette attitude de travail se traduit par d'excellents produits, conçus pour durer, même dans le secteur de la céramique sanitaire.



L'azienda

The company - L'entreprise

Dal 1990 Hafro è uno dei tre brand di Gruppo Geromin, azienda veneziana che da oltre 70 anni è sinonimo di eccellenza nella progettazione e realizzazione di ambienti wellness e arredo bagno. La visione del Gruppo unisce la cultura del Made in Italy a una continua attività di ricerca e innovazione, per combinare le tecnologie più all'avanguardia alle ultime tendenze estetiche. Con l'obiettivo di fornire sempre il meglio in termini di qualità, funzionalità e design, Gruppo Geromin produce vasche da bagno e vasche idromassaggio, saune e hammam, arredo bagno e lavanderia, docce, rubinetteria e accessori. Dal 2023 Gruppo Geromin introduce per la prima volta una collezione di Ceramiche sotto il brand Hafro, che va a completare il progetto di Total Living Bathroom & Wellness dell'azienda.



Since 1990, Hafro has been one of the three brands of Gruppo Geromin, a Venetian company that for over 70 years has been known for excellence in design and creation of wellness environments and bathroom furniture. The Group's vision combines the quality of Made in Italy with continuous research and innovation to combine the latest technologies with the newest aesthetic trends.

With the aim of always providing the best in terms of quality, functionality and design, Gruppo Geromin produces bathtubs and whirlpool baths, saunas and hammams, bathroom and laundry furniture, showers, taps and accessories. As of 2023, Gruppo Geromin will for the first time introduce a collection of ceramics under the Hafro brand, which will complement the company's Total Living Bathroom & Wellness project.

Depuis 1990, Hafro est l'une des trois marques de Geromin, un groupe qui, depuis plus de 70 ans, est synonyme d'excellence dans la conception et la création d'environnements de bien-être et de meubles de salle de bains. La vision du groupe associe la culture du Made in Italy à la recherche et à l'innovation continues pour combiner les technologies les plus avancées avec les dernières tendances esthétiques. Dans le but de toujours offrir le meilleur en termes de qualité, de fonctionnalité et de design, le groupe produit des baignoires et des bains à remous, des saunas et des hammams, des meubles de salle de bains et de buanderie, des douches, de la robinetterie et des accessoires. À partir de 2023, il introduira également la céramique Hafro, qui vient compléter le projet Total Living Bathroom.

Stabilimenti aziendali

Company establishments - Établissements industriel



Hafro - Sanitari



Hafro - Sauna Vita



Geromin



Il rispetto del territorio

Respect for the territory - Le respect du territoire

Gruppo Geromin fa della sostenibilità uno dei suoi valori principali e si pone l'obiettivo di generare il minor impatto ambientale possibile con i suoi processi industriali, nel rispetto del territorio in cui opera. Per le Forme Ceramiche di Hafro, il Gruppo ha dedicato particolare attenzione alla riduzione dell'impiego di risorse idriche, sia nella fase di progettazione del prodotto che nel suo utilizzo finale. L'acqua, nel territorio della laguna veneziana, è un elemento vivo e fondamentale per l'identità del luogo, che Gruppo Geromin rispetta e valorizza.

Gruppo Geromin makes sustainability one of its main values and aims to have the lowest possible environmental impact with its industrial processes, while respecting the territory in which it operates. For Hafro Ceramic Forms, the Group has paid particular attention in reducing the use of water resources, both during the design phase of the product and in its final use. Water, in the territory of the Venetian lagoon, is a living element and fundamental for the identity of the area, which Gruppo Geromin respects and promotes.

Le Groupe Geromin fait de la durabilité l'une de ses valeurs fondamentales et vise à réduire au maximum l'impact de ses processus industriels sur l'environnement, tout en respectant le territoire sur lequel il opère. Pour les Formes Céramiques de Hafro, le Groupe a porté une attention particulière à la réduction de l'utilisation des ressources hydriques, aussi bien dans la phase de conception du produit que dans son utilisation finale. L'eau, dans le territoire situé juste à côté de la lagune vénitienne, est un élément vivant et fondamental pour l'identité du lieu, que le groupe Geromin respecte et met en valeur.

Innovazione

Innovation - L'innovation

La ricerca di Gruppo Geromin è volta alla scoperta delle più recenti innovazioni tecnologiche per una proposta bagno e wellness sempre all'avanguardia. Le nuove tecnologie, unite ad un alto livello di expertise, trasformano i risultati della ricerca in sistemi di produzione evoluti. I prodotti di Gruppo Geromin si distinguono per i materiali dalle eccellenti caratteristiche tecniche ed estetiche, studiati attentamente per soddisfare ogni esigenza.



Gruppo Geromin's research is aimed at discovering the latest technological innovations for an always advanced bathroom and wellness solution. New technologies, combined with a high level of experience, transform the results of research into evolved production systems. Gruppo Geromin products are distinguished by materials with excellent technical and aesthetic characteristics, carefully developed to satisfy every customer's request.

La recherche du Groupe Geromin vise à découvrir les dernières innovations technologiques pour une proposition de salle de bains et de bien-être toujours à l'avant-garde. Les nouvelles technologies, associées à un haut niveau d'expertise, transforment les résultats de la recherche en systèmes de production avancés. Les produits du Groupe Geromin se distinguent par des matériaux aux excellentes caractéristiques techniques et esthétiques, soigneusement étudiés pour satisfaire toutes les exigences.

I Designers

The Designers - Les Designers



Andrea Rosset | Antonio Bullo

Antonio Bullo nasce nel 1952 a Chioggia, città della laguna veneziana legata in modo intrinseco all'acqua, elemento che influenzerà in modo sostanziale il suo approccio al design. Dopo essersi diplomato al Magistero per la Ceramica di Faenza e, in seguito, all'Accademia di Belle Arti di Venezia in Scultura, comincia a lavorare con alcune tra le maggiori aziende del settore ceramica, esplorando le potenzialità del materiale e divenendone uno specialista. Più tardi amplia la sua attività professionale nell'ambito dell'arredo bagno e insegna come docente di Disegno Industriale presso l'I.S.I.A di Faenza. Oggi è conosciuto sia in ambito italiano che internazionale e si dedica a progetti di design industriale nei settori dell'arredo bagno e del wellness. La filosofia alla base del suo lavoro è quella di creare un prodotto che combini la tradizione con la novità, la massima funzionalità tecnica con le possibilità espressive della materia ceramica. Andrea Rosset è collaboratore di Antonio Bullo da molti anni e condivide con lui la stessa filosofia e approccio al design.

Antonio Bullo was born in 1952 in Chioggia, a city in the Venetian lagoon that is intrinsically linked to water, an element that will significantly influence his approach to design. After graduating from the Magistero per la Ceramica in Faenza and later from the Accademia di Belle Arti in Venice in Sculpture, he began working with some of the major companies in the ceramic sector, exploring the potential of the material and becoming a specialist in it. He later expanded his professional activity in the field of bathroom furnishings and taught Industrial Design at the I.S.I.A in Faenza. Today he is known both in Italy and internationally and is dedicated to industrial design projects in the fields of bathroom furniture and wellness. The philosophy behind his work is to create a product that combines tradition with novelty, maximum technical functionality with the expressive possibilities of ceramic material. Andrea Rosset has worked with Antonio Bullo for many years and shares the same philosophy and approach to design.

Antonio Bullo est né en 1952 à Chioggia, une ville de la lagune vénitienne intrinsèquement liée à l'eau, un élément qui influencera considérablement son approche du design. Diplômé du Magistero per la Ceramica de Faenza, puis de l'Accademia di Belle Arti de Venise en sculpture, il commence à travailler avec quelques-unes des principales entreprises du secteur de la céramique, explorant les potentialités du matériau et devenant un spécialiste. Il étend ensuite son activité professionnelle au secteur des meubles de salle de bains et enseigne le design industriel à l'I.S.I.A. de Faenza. Aujourd'hui, il est connu en Italie et à l'étranger et se consacre à des projets de design industriel dans les secteurs de l'ameublement de salle de bains et du bien-être. La philosophie qui sous-tend son travail est de créer un produit qui allie tradition et nouveauté, fonctionnalité technique maximale et possibilités expressives du matériau céramique. Andrea Rosset travaille avec Antonio Bullo depuis de nombreuses années et partage la même philosophie et la même approche du design.

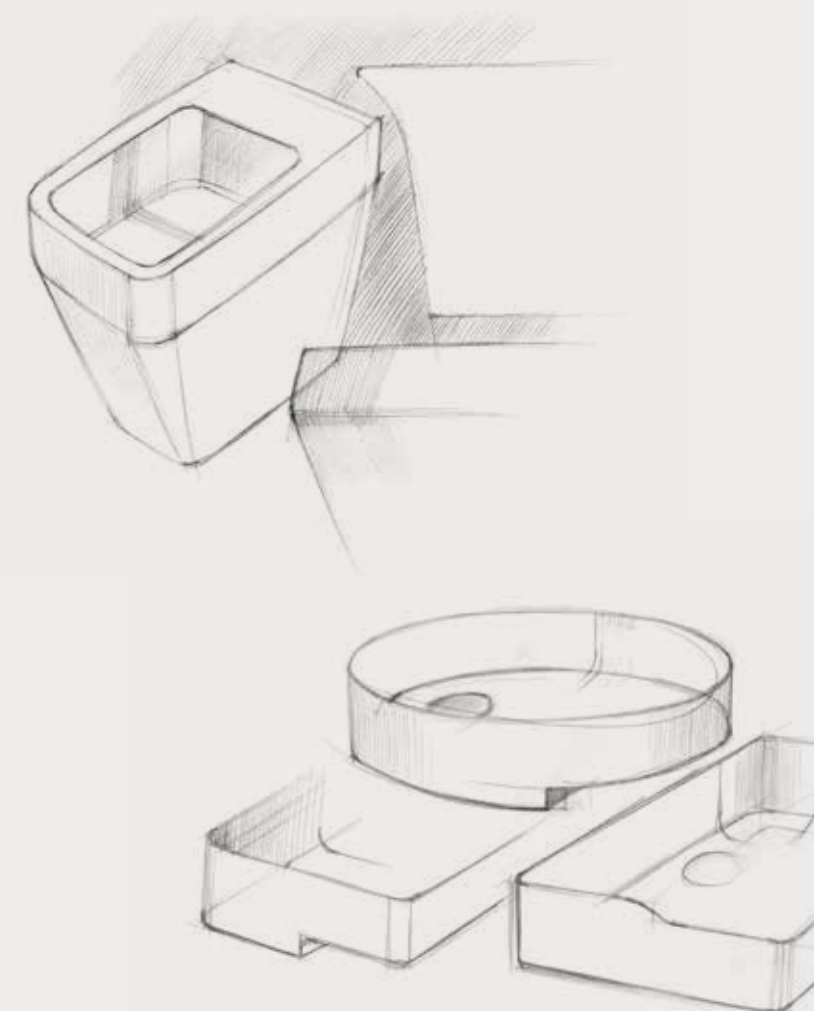

Eccellenza Made in Italy

Italian Excellence - L'excellence du Made in Italy

L'attenta selezione e ricerca dei materiali da parte del Gruppo garantisce le migliori materie prime per i suoi prodotti, tutti rigorosamente Made in Italy: materiali sicuri che durano nel tempo, perché per Geromin la casa è un luogo sacro.

L'alta qualità delle finiture e l'accuratezza delle lavorazioni assicurano la massima funzionalità e permettono di valorizzare l'ambiente bagno anche dal punto di vista stilistico.

The Group's careful selection and research of materials guarantees the best raw materials for all products, which are rigorously Made in Italy: solid materials that last over time, because for Geromin home is a sacred place. The high quality of finishes and the manufacturing accuracy ensure maximum functionality and allow the bathroom environment to increase in value also from a stylistic point of view.

La sélection et la recherche minutieuses des matériaux par le Groupe garantissent les meilleures matières premières pour ses produits, tous rigoureusement Made in Italy: des matériaux sûrs et indestructibles qui durent dans le temps, parce que pour Geromin la maison est un environnement important. La qualité des finitions et la précision de l'exécution garantissent une fonctionnalité maximale et permettent de mettre en valeur l'environnement de la salle de bains, même d'un point de vue stylistique.



GARANZIA 10 ANNI
10
 10 YEARS WARRANTY

Colore che arreda

Colours that decorate - La couleur qui personnalise

La collezione Forme Ceramiche di Hafro offre la possibilità di rendere il bagno un luogo davvero intimo e personale, grazie alle ceramiche colorate: una caratteristica che porta l'espressione di sé e la personalizzazione dell'ambiente bagno a un livello superiore. Sono 4 le colorazioni disponibili: sabbia, grigio e nero solo in versione opaca, mentre bianco anche nella classica versione lucida.

Forme Ceramiche collection by Hafro offers the possibility of making your bathroom a truly intimate and personal place, thanks to coloured ceramics: a feature that takes self-expression and personalization of the bathroom to a higher level. Four colours are available: sand, grey and black only in matt version, and white also in the classic glossy version.

La collection Formes Céramiques de Hafro offre la possibilité de faire de la salle de bains un lieu vraiment intime et personnel, grâce à la céramique colorée: une caractéristique qui pousse l'expression personnelle et la personnalisation de la salle de bains à un niveau supérieur. Quatre couleurs sont disponibles, qui peuvent varier en fonction du modèle.

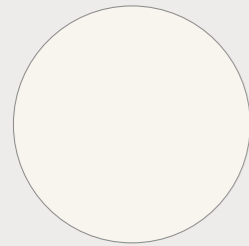

Bianco lucido

Glossy White
Blanc brillant



Bianco opaco

Matt White
Blanc mat



Sabbia opaco

Matt Sand
Sable mat

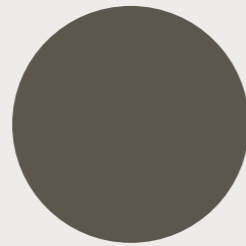

Grigio opaco

Matt Grey
Gris mat

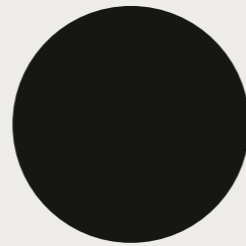

Nero opaco

Matt Black
Noir mat



Una superficie resistente e antibatterica

A resistant and antibacterial surface - Une surface résistante et antibactérienne

Il ciclo di cottura delle Ceramiche Hafro ha una durata totale di 13 ore, con temperature che raggiungono i 1250° C. Lo scrupoloso controllo in tutte le fasi di cottura delle ceramiche assicura al processo di sinterizzazione un'eccellente uniformità del prodotto, con una superficie non porosa, specchiante e resistente a macchie e abrasioni. Inoltre, l'azione del trattamento antibatterico dona alle ceramiche maggiore brillantezza, resistenza e igiene, garantendo un prodotto più pulito e sicuro, testimone dell'attenzione di Hafro per la salute delle persone.

The Hafro Ceramics firing stage lasts 13 hours and the temperature reaches 1250°C. From the sintering process, a homogenous product is obtained with a smooth, mirror-like surface that is resistant to stains and abrasions. Thanks to the combined action with the antibacterial liquid treatment, surfaces are more impermeable to germs and bacteria. The result is cleaner and safer sanitaryware, a proof of Hafro's attention to people's health.

Le cycle de cuisson de Hafro Ceramics dure au total 13 heures et la température atteint 1250°C. Le processus de frittage permet d'obtenir un produit parfaitement homogène avec une surface lisse et réfléchissante, résistante aux taches et aux abrasions. Grâce à l'action combinée du traitement liquide antibactérien, les surfaces sont plus imperméables aux germes et aux bactéries. Il en résulte des articles sanitaires plus propres et plus sûrs, ce qui témoigne de la préoccupation de Hafro pour la santé des personnes.



Temperatura di cottura 1250° C

Firing temperature 1250°

Température de cuisson 1250° C

Ciclo di cottura di 13 ore

Firing stage 13 hours

Cycle de cuisson de 13 heures

Superficie ceramica planare

Planar ceramic surface

Surface céramique plane

Smaltatura idrorepellente

Water-repellent enamelling - Émailage imperméable à l'eau



I sanitari di Hafro sono realizzati totalmente in vetrochina: una ceramica smaltata a pasta vetrificata, caratterizzata dalla miscela di minerali purissimi, che la rendono idrorepellente e molto resistente.

Vista la cura che Hafro dedica a tutte le parti strutturali, anche il sifone interno ha la stessa composizione, a differenza di quanto accade per i sanitari tradizionali. Questa caratteristica facilita la pulizia e l'igiene, rende più efficiente lo scarico e consente di risparmiare acqua.

Hafro's sanitaryware is made entirely of vitreous china: a glazed ceramic material characterised by the mixture of pure minerals, which make it water-repellent and very resistant. Hafro dedicates special care to all structural parts, even the internal siphon has the same composition, unlike traditional sanitaryware. This feature facilitates cleaning and hygiene, makes flushing more efficient and saves water.

Les sanitaires Hafro sont entièrement fabriqués en porcelaine vitrifiée, une céramique émaillée caractérisée par un mélange de minéraux purs qui la rendent hydrofuge et très résistante. Grâce au soin apporté par Hafro à toutes les parties structurelles, le siphon interne a également la même composition, contrairement aux appareils sanitaires traditionnels. Cette caractéristique facilite le nettoyage et l'hygiène, rend la chasse d'eau plus efficace et permet d'économiser de l'eau.

Lavabi dai bordi sottili
Washbasins with thin edges
Lavabos avec bords fins



Superfici perfette con l'innovativo smalto Hafrosanit

Perfect surfaces with the innovative Hafrosanit glaze
Des surfaces parfaites avec la nouvelle émail Hafrosanit

Dalla costante attività di ricerca e sviluppo di Gruppo Geromin nasce l'innovativo smalto *Hafrosanit*, studiato e testato per assicurare performance estetiche elevate e durevolezza nel tempo. Il nuovo ed esclusivo impasto ceramico, inoltre, permette di realizzare lavabi che raggiungono uno spessore di soli 6 mm e ne mantiene inalterati stabilità e geometria.

From Gruppo Geromin's constant research and development comes the innovative *Hafrosanit* glaze, designed and tested to ensure high aesthetic performance and durability over time. Furthermore, the new and exclusive ceramic mixture reduces the thickness of the washbasins up to just 6 mm and keeps their stability and design unaltered.

La recherche et le développement constants du groupe Geromin ont abouti à l'émail innovant *Hafrosanit*, conçu et testé pour garantir des performances esthétiques élevées et une durabilité dans le temps. De plus, le nouveau mélange céramique exclusif permet de réduire l'épaisseur des lavabos à seulement 6 mm, tout en conservant leur stabilité et leur géométrie.

Risparmio idrico effettivo

Effective water saving - Économie d'eau réelle

Il design dei sanitari Hafro è stato concepito con una particolare attenzione all'utilizzo consapevole delle risorse idriche. Il sistema di scarico permette un risparmio idrico notevole, poiché utilizza 3 litri d'acqua contro i 6 degli impianti più diffusi. Questo è un dettaglio non trascurabile al momento della scelta dei sanitari da installare, sia in ambito domestico che nel contract, per coloro che hanno un occhio di riguardo alla sostenibilità ambientale.

The design of Hafro sanitaryware has been developed with a focus on the conscious use of water resources. The drain system allows considerable water savings, as it uses 3 litres of water as opposed to the 6 litres of the most common systems. This is a detail that should not be forgotten when choosing sanitaryware for installation, whether in the domestic or contract sector, for those who care about environmental sustainability.

Les sanitaires Hafro ont été conçus en accordant une attention particulière à l'utilisation consciente des ressources en eau. Le système de chasse d'eau permet de réaliser des économies d'eau considérables, puisqu'il utilise 3 litres d'eau au lieu des 6 litres des systèmes les plus courants. Il s'agit d'un détail à ne pas négliger lors du choix des appareils sanitaires à installer, que ce soit dans le secteur domestique ou contractuel, pour ceux qui sont soucieux de la durabilité de l'environnement.

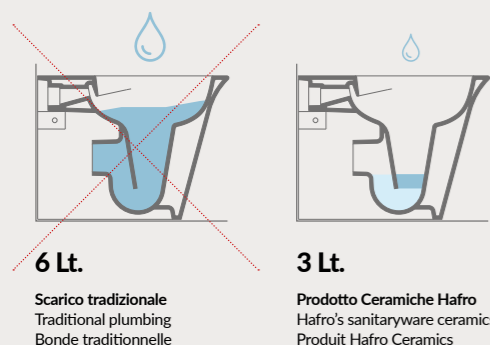

6 Lt.

Scarico tradizionale
Traditional plumbing
Bonde traditionnelle

3 Lt.

Prodotto Ceramiche Hafro
Hafro's sanitaryware ceramics
Produit Hafro Ceramics

Ideali per ristrutturazioni

Ideal for renovations - Idéal pour les rénovations

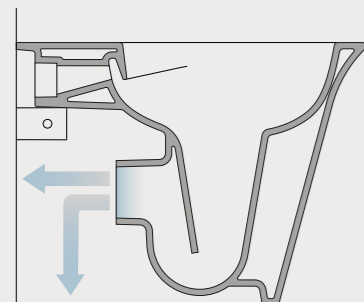

Le ceramiche di Hafro sono sanitari di nuova generazione che rispondono alle più recenti richieste di mercato. Hanno un sistema con scarico traslato che ne facilita l'installazione in caso di ristrutturazione del bagno, poiché non richiede interventi di muratura sugli impianti preesistenti. Il sifone, infatti, ha speciali curve tecniche che consentono di regolarne la posizione.

Hafro ceramics are new generation sanitaryware that meet the latest market demands. They have a shifted drain system that simplifies installation in case of bathroom renovation, as it does not require masonry work on existing installations. The siphon has special pan connectors that allow its position to be adjusted.

Les sanitaires Hafro sont de nouvelle génération et répondent aux dernières exigences du marché. Ils sont dotés d'un système d'évacuation qui facilite leur installation en cas de rénovation de la salle de bains, car il ne nécessite pas de travaux de maçonnerie sur les installations existantes. En effet, le siphon possède des courbes techniques spéciales qui permettent d'ajuster sa position.



Il sistema Rimless

Rimless system - Le système Rimless

Il vaso Rimless, detto anche senza brida, ha un unico getto d'acqua, concentrato in un solo punto, che elimina il bordo interno del wc e ne favorisce la pulizia. Grazie anche al bacino tondo, lo scorrimento dell'acqua è più agevole e meno rumoroso, per un maggiore comfort dell'ambiente bagno. La funzionalità e l'igiene sono assicurate dalla potenza del getto, che seppur con una minore quantità di acqua, riesce a trasportare via tutti i residui in modo efficace.

The rimless WC has a single jet of water, focused in one single spot, which eliminates the inner rim of the WC and facilitates its cleaning. Thanks also to the round washbasin, the water flow is easier and less noisy, for a more comfortable bathroom environment. Functionality and hygiene are ensured by the powerful jet, which, even with a smaller quantity of water, is able to effectively flush all residues away.

Les sanitaires Rimless, également appelés sans bride, disposent d'un seul jet d'eau, concentré en un seul point, qui élimine le rebord intérieur des toilettes et facilite le nettoyage. Grâce à la cuvette ronde, l'écoulement de l'eau est plus régulier et moins bruyant, pour un plus grand confort dans la salle de bains. La fonctionnalité et l'hygiène sont assurées par la puissance du jet qui, même avec une petite quantité d'eau, est en mesure d'évacuer efficacement tous les résidus.

Sgancio rapido e chiusura rallentata

Quick release and slow closing - Dégagement rapide et fermeture lente

I sedili presentano tecnologie innovative che migliorano il comfort abitativo e l'igiene. Il sistema a sgancio rapido permette di togliere e mettere il coprivaso velocemente, senza sforzo, e di accedere in modo semplice a tutte le superfici in fase di pulizia, per prolungare la vita dei prodotti e garantire igiene totale.

Il coprivaso ha anche una chiusura rallentata e silenziosa, che preserva la bellezza della ceramica. I modelli Fio, Avigo e Stino hanno una chiusura rallentata certificata per 30.000 cicli, mentre il modello Voga per 50.000 cicli.

The seats feature innovative technologies that improve living comfort and hygiene. The quick-release system allows the WC seat cover to be removed and put on quickly, effortlessly, and provides easy access to all surfaces during cleaning, prolonging product life and ensuring total hygiene.

The cover also has a slow, silent closing mechanism that preserves the beauty of the ceramic. The Fio, Avigo and Stino models have a slow closing mechanism certified for 30,000 cycles, while the Voga model for 50,000 cycles.

Les sièges sont dotés de technologies innovantes qui améliorent le confort de vie et l'hygiène. Le système à dégagement rapide permet d'enlever et de remettre la siège rapidement, sans effort, et facilite l'accès à toutes les zones à nettoyer: pour prolonger la durée de vie des produits et garantir une hygiène totale. La siège est également doté d'un mécanisme de fermeture lente et silencieuse qui préserve la beauté de la céramique. Les modèles Fio, Avigo et Stino sont dotés d'un mécanisme de fermeture lente certifié pour 30 000 cycles, et le modèle Voga pour 50 000 cycles.



Sistemi di fissaggio invisibile

Invisible fixing systems - Systèmes de fixation invisibles

Sia nella versione a terra che nella versione sospesa, i sanitari Hafro hanno un sistema di fissaggio completamente invisibile: tutto è nascosto all'interno della ceramica, incluse le componenti tecniche del sanitario, e il risultato è esteticamente perfetto. Anche l'installazione è più semplice rispetto ai sistemi standard e rende più rapido sia il montaggio che eventuali manutenzioni. Nelle versioni a terra, inoltre, non sono necessari fori e fissaggio al pavimento e l'installazione è sicura anche sul cartongesso.

In both the ground and wall-hung versions, Hafro sanitaryware has a completely invisible fixing system: everything is hidden inside the ceramic, including the technical components of the sanitaryware, and the result is aesthetically perfect. Installation is also easier than with standard systems, making both assembly and maintenance quicker. In addition, in the ground-installed versions, there is no need for drilling and fixing to the floor, and installation is safe even on plasterboard.

Qu'ils soient posés au sol ou suspendus, les articles sanitaires Hafro sont dotés d'un système de fixation totalement invisible: tout est caché à l'intérieur de la céramique, y compris les composants techniques de l'article sanitaire, et le résultat est esthétiquement parfait. L'installation est aussi plus simple que les systèmes standard, ce qui rend l'installation et la maintenance plus rapides. En outre, les versions au sol ne nécessitent pas de perçage ni de fixation au sol, et l'installation est également sûre sur les plaques de plâtre.

fischer 

Sistemi di fissaggio facile e rapido per sanitari

Easy and quick fixing systems for sanitaryware - Systèmes de fixation simple et rapides pour les sanitaires



WB7 (Invisibile)
Per sanitari a terra senza nessun accesso dall'esterno delle ceramiche.

WB7 (Invisibile)
For ground-installed sanitaryware with no access from outside the ceramics.

WB7 (Invisibile)
Pour les sanitaires avec installation au sol sans accès depuis l'extérieur des céramiques.



WB9 2.0 (Invisibile)
Per sanitari sospesi partendo da N°2 barre M12 preinstallate a muro.

WB9 2.0 (Invisibile)
For wall-hung sanitaryware from No. 2 M12 bars pre-installed on the wall.

WB9 2.0 (Invisibile)
Pour les sanitaires suspendus à partir de 2 barres M12 préinstallées sur le mur.



WB-KLIX (Ultra rapido)
Per sanitari sospesi senza nessun accesso dall'esterno delle ceramiche.

WB-KLIX (Ultra-rapido)
For wall-hung sanitaryware without any access from outside the ceramics.

WB-KLIX (Ultra-rapido)
Pour les sanitaires suspendus sans accès à l'extérieur des céramiques.



Il culto del benessere è parte della nostra essenza.

The cult of wellbeing is part of our essence.
Le culte du bien-être fait partie de notre essence.





AVIGO

Linea

A Chioggia, città d'origine del designer, si va "a Vigo" per volgersi al mare, all'acqua, quindi ad uno dei più appaganti piaceri del vivere.

Il bagno Avigo è disegnato per inserirsi nella tipicità dell'abitare italiano rinnovando con essenzialità la tradizione. Avigo tra le collezioni sanitarie si distingue per la numerosa e completa proposta dei suoi elementi sempre coordinati nel design e sostenuti dall'alto livello qualitativo.

In Chioggia, the designer's hometown, one goes "to Vigo" to turn to the sea, to the water, therefore to one of the most satisfying pleasures of living.

Avigo is designed to fit into the typicality of Italian living by renewing tradition with essentiality. Among the sanitaryware collections, Avigo stands out for the numerous and complete range of its elements, always coordinated in design and supported by a high quality level.

À Chioggia, la ville natale du designer, on va "à Vigo" pour aller à la mer, vers l'eau, et donc vers l'un des plaisirs les plus satisfaisants de la vie. Avigo est conçue pour s'intégrer dans le mode de vie italien typique en renouvelant la tradition avec essentialité. Parmi les collections sanitaires, Avigo se distingue par la multiplicité et l'exhaustivité de ses éléments, toujours coordonnés dans le design et soutenus par un niveau de qualité élevé.



Il design di Avigo si distingue per il bordo piano,
che si apre con delicatezza verso l'esterno.

Avigo's design is distinguished by its flat edge, which
opens gently outwards.

Le design d'Avigo se distingue par son bord plat,
qui s'ouvre délicatement vers l'extérieur.



► **Avigo - Vasi e Bidet a Terra 56x36**
Ground-installed WCs and Bidets - WC et bidets au sol





► **Avigo - Vasi e Bidet sospesi 56x36**
Wall-hung WCs and Bidet - WC et bidet suspendus





Avigo Ø 39 x H11 cm in ceramica
Ceramic - Céramique



Avigo 60x39 x H11 cm in ceramica
Ceramic - Céramique



Avigo 67x45 x H11 cm in ceramica
Ceramic - Céramique

Il lavabo Avigo è un lavabo da appoggio, disponibile in forme diverse: ovale oppure un cerchio perfetto. In questo modo si adatta a diversi top, anche quelli più piccoli.

Avigo is a countertop washbasin, available in different shapes: oval or a perfect circle. This allows it to be adapted to different countertops, even the smallest ones.

Le lavabo Avigo est un lavabo à poser, disponible en différentes formes: ovale ou cercle parfait. Il s'adapte ainsi à différents plans de toilette, même les plus petits.



I sanitari back-to-wall riducono l'ingombro, facilitano la pulizia ed esaltano l'arredo. Gli elementi tecnici sono del tutto nascosti, per un piacere visivo totale.

The back-to-wall sanitaryware reduce clutter, facilitate cleaning and emphasise the décor. The technical elements are completely hidden, for a total visual pleasure.

La céramique sanitaire encastrée dans le mur réduit l'encombrement, facilite le nettoyage et met en valeur le décor. Les éléments techniques sont entièrement dissimulés, pour un plaisir visuel total.



La vasca Avigo è in Mineraltek, un composto minerale elegante alla vista, pratico nella pulizia e resistente nel tempo.

The Avigo bathtub is made of Mineraltek, a mineral compound that is elegant to the eye, practical to clean and durable.

La baignoire Avigo est en Mineraltek, un composé minéral très élégant à l'œil, pratique à nettoyer et durable.

Vasca Avigo - 170 x 75 - versione lucido
Avigo bathtubs, glossy version - Baignoire Avigo, version brillante





► **Vasca Avigo - 170 x 75 - versione lucido**
 Avigo bathtubs, glossy version - Baignoire Avigo, version brillante



Lucida oppure opaca, monocoloro oppure bicolore:
la vasca Avigo personalizza con stile l'ambiente bagno.

Glossy or matt, single or two-tone: the Avigo bathtub
customises your bathroom with style.

Brillante ou mat, unicolore ou bicolore: la baignoire
Avigo personnalise la salle de bains avec style.

Vasca Avigo - 170 x 75 - versione bicolore Rosa Antico
Two-tone version Antique Pink - Version bicolore Rose Antique



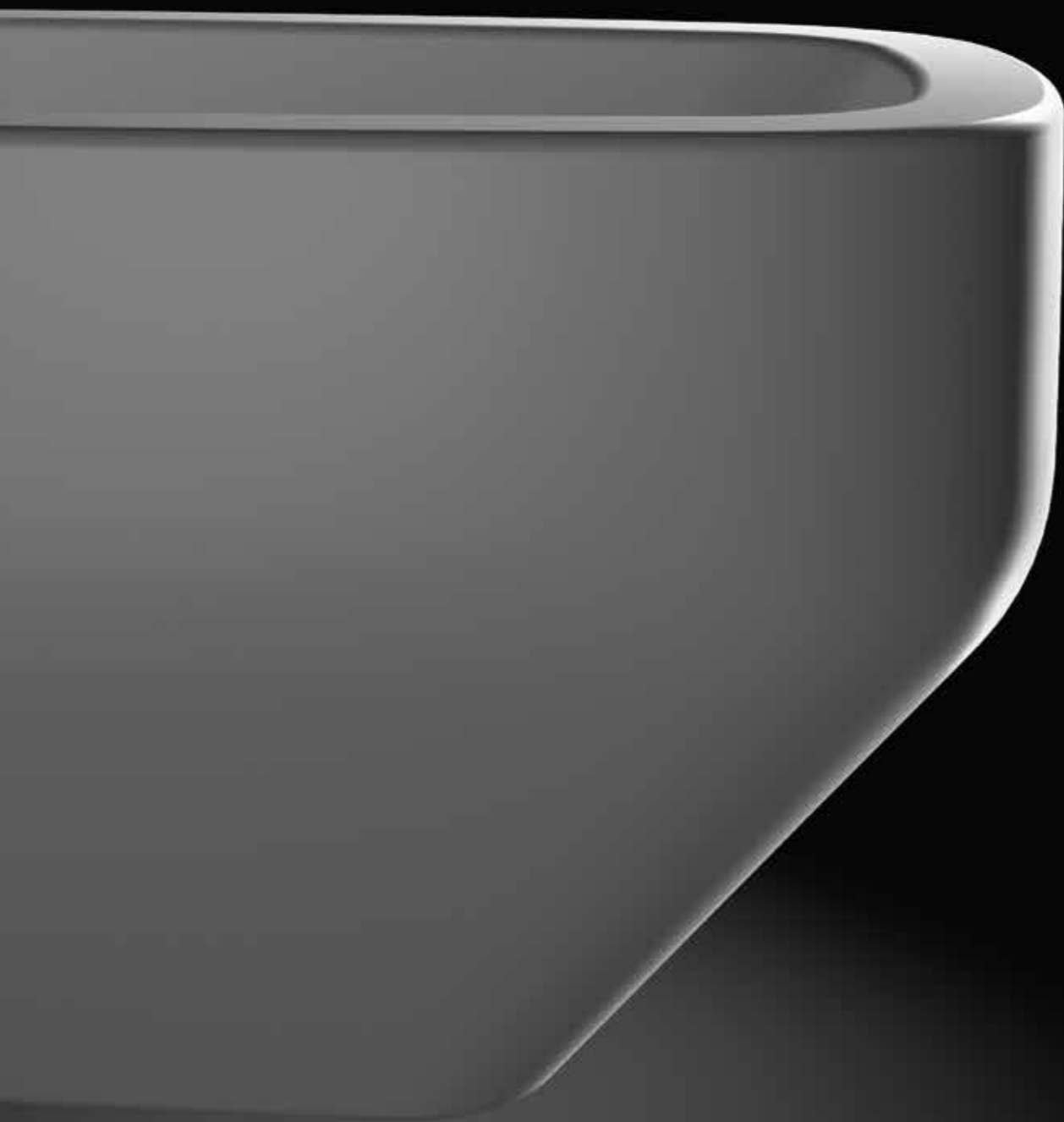

FIO

Linea

A Venezia i ragazzi li chiamiamo “Fioi”, una parola viva, ben definita nella sua breve composizione adatta a sottolineare il design di una collezione dalle caratteristiche di Fio. Un design segnato con linearità dalla separazione delle superfici e dalla rotondità dei raccordi che aggiungono funzionalità ad un solido corpo quadrangolare.

In Venice, young boys are called ‘Fioi’, a living word, well-defined in its short composition, suitable for highlighting the design of a collection with the characteristics of Fio. A design marked with linearity by the separation of surfaces and the roundness of fittings that add functionality to a solid quadrangular body.

À Venise, les garçons sont appelés “Fioi”, un mot vivant, bien défini dans sa composition courte pour souligner la conception d’une collection avec des caractéristiques typiques de Fio. Un design marqué par la linéarité et la rondeur, raccords qui ajoutent de la fonctionnalité à un corps quadrangulaire solide.



Sanitari e lavabo hanno un design unico e distintivo,
personalizzabile con il colore.

Sanitaryware and washbasins have a unique and distinctive
design that can be customised with colour.

Les sanitaires et les lavabos ont un design unique et distinctif
qui peut être personnalisé par des couleurs.

Fio - Vasi e Bidet a Terra 55x36
Ground-installed WCs and Bidets - WC et bidet au sol





Lavabo Albo - 65x39 bianco
 Albo washbasin, white - Lavabo Albo, blanc





► **Fio - Vasi e Bidet a Terra 55x36**
Ground-installed WCs and Bidets - WC et bidet au sol





► **Fio - Vasi e Bidet Sospesi 55x36**
Wall-hung WCs and Bidets - WC et bidet suspendus







La vasca freestanding Fio è un cerchio perfetto, un elemento di arredo che racchiude corpo e mente in un caldo abbraccio. È in Mineraltek lucido oppure opaco e l'esterno si può personalizzare con finitura colorata.

The Fio freestanding bathtub is a perfect circle, a piece of furniture that encloses body and mind in a warm embrace. It is made of glossy or matt Mineraltek and the exterior can be customised with a coloured finish.

La baignoire autoportante Fio est un cercle parfait, un meuble qui enveloppe le corps et l'esprit d'une étreinte chaleureuse. Elle est fabriquée en Mineraltek poli ou mat et l'extérieur peut être personnalisé avec une finition colorée.

► **Vasca Fio - Ø 125 - versione bicolor nero opaco**
Fio bathtub, two-tone version matt Black
Baignoire Fio, version bicolore noir mat





► Vasca Fio - Ø 125 - versione bicolor Grigio Londra
 Fio bathtub, two-tone version London Grey - Baignoire Fio, version bicolore Gris Londres





STINO

Linea

Stino è nel nome del sito aziendale che applicato a questa collezione dà un particolare senso di appartenenza a questo prodotto. Stino si propone nella sua essenziale integrità minimalista con una architettura composta da figure geometriche elementari, pure, in evoluzione sulla migliore tradizione italiana del design. Un progetto compatto, funzionale in sintonia con il rigore degli attuali complementi di arredo.

Stino is the name of the company site, which when applied to this collection gives it a special sense of belonging. Stino is proposed in its essential minimalist integrity with an architecture composed of elementary, pure geometric figures, evolving in the best Italian design tradition. A compact, functional design in harmony with the rigour of today's furnishing complements.

Stino est le nom du lieu d'origine de l'entreprise, qui, appliqué à cette collection, lui confère un sentiment d'appartenance particulier. Stino est proposé dans son intégrité minimaliste essentielle, avec une architecture composée de figures géométriques élémentaires et pures, évoluant dans la meilleure tradition du design italien. Un design compact et fonctionnel en phase avec la rigueur des accessoires d'ameublement d'aujourd'hui.



La versione sospesa esalta il design dei sanitari e l'essenzialità delle forme.

The suspended version enhances the design of the sanitaryware and the essentiality of the shapes.

La version suspendue valorise le design des sanitaires et l'essentialité des formes.

Stino - Vasi e Bidet Sospesi 52x36
Wall-hung WCs and Bidets - WC et bidet suspendus

Un dettaglio di stile ricercato: la piletta a filo in ceramica a scarico libero crea armonia e continuità visiva.

A sophisticated style detail: the flush ceramic free flowing drain creates harmony and visual continuity.

Un détail de style sophistiqué: la bonde en céramique à écoulement libre crée une harmonie et une continuité visuelle.

Ceramiche di Hafro

New collection





► **Stino - Vasi e Bidet a Terra 52x36**
Ground-installed WCs and Bidets - WC et bidet au sol





VOGA

Linea

In un impianto disegnato secondo regola a distinguere l'originalità della collezione Voga è il dinamico fregio che dal fianco percorre gran parte della sua superficie. Un segno che modella in modo scultoreo una forma creata per inserirsi nell'attualità di un mercato saturo di normalità.

In a layout designed according to rules, what distinguishes the originality of the Voga collection is the dynamic frieze that runs from the side along most of its surface. A sign that sculpturally moulds a shape created to fit into the actuality of a market saturated with normality.

Un produit conçu selon des règles, ce qui distingue l'originalité de la collection Voga, c'est la frise dynamique qui court sur le côté sur la majeure partie de sa surface. Un signe qui sculpte une forme créée pour s'inscrire dans l'actualité d'un marché saturé de normalité.

Per Voga un sistema di fissaggio ancora più avanzato e rapido.

For Voga an even more advanced and quicker fixing system.

Pour Voga, un système de fixation encore plus évolué et rapide.





► **Voga - Vasi e Bidet Sospesi 54x36**
Wall-hung WCs and Bidets - WC et bidet suspendus



**Rendere il bagno un ambiente davvero intimo:
le ceramiche colorate sono di grande tendenza e
permettono di personalizzare al massimo la stanza.**

Making the bathroom a truly intimate environment:
coloured ceramics are very trendy and allow you to
customize the room to a next level.

Faire de la salle de bains un lieu d'intimité:
les céramiques colorées sont très tendance et
permettent de personnaliser au maximum la pièce.

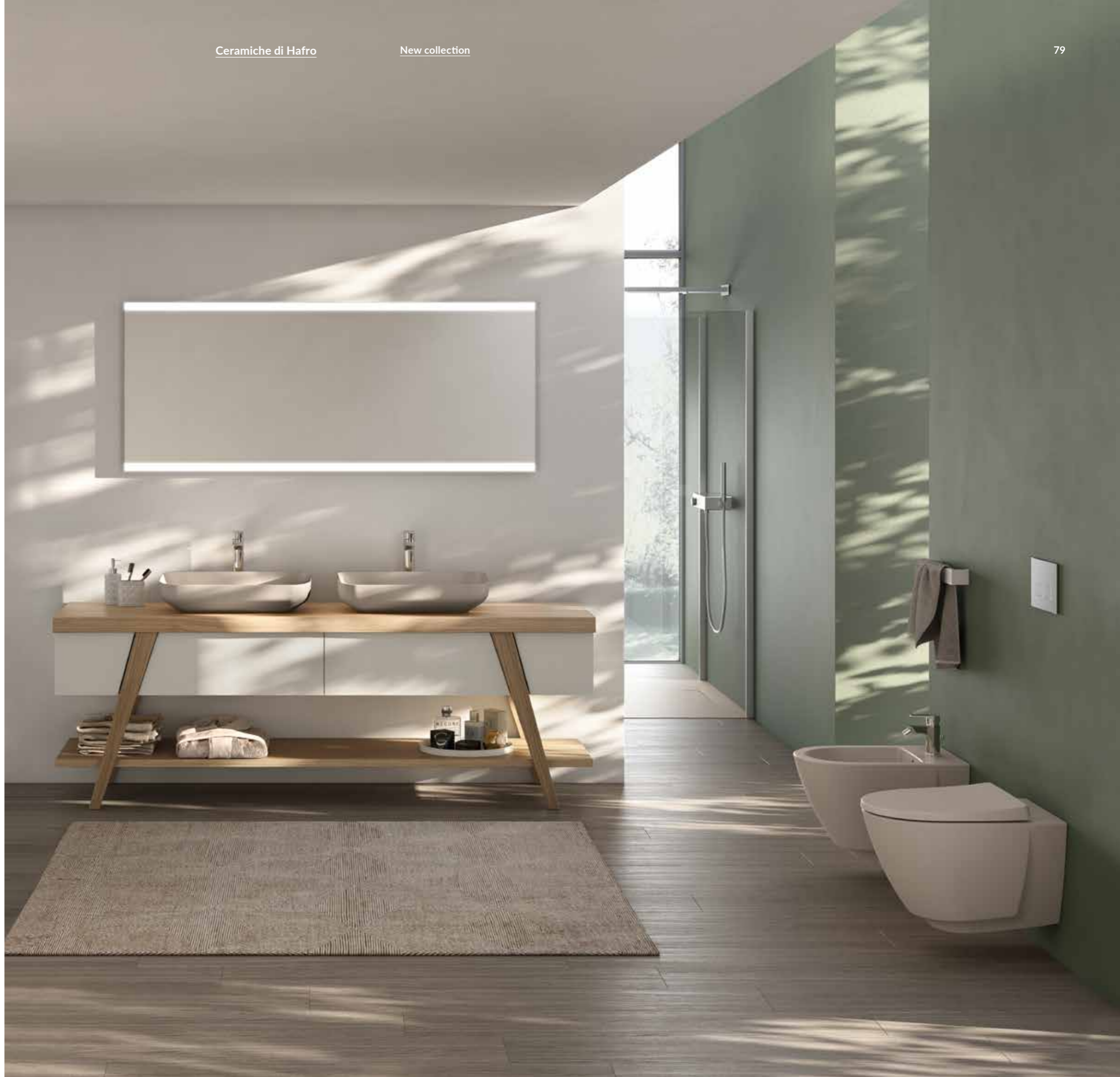



Altino è un lavabo da appoggio rettangolare, con angoli morbidi e arrotondati. Il design leggero e delicato è esaltato dallo spessore della ceramica: soli 6 mm, perfettamente resistenti.

Altino is a rectangular countertop washbasin with soft, rounded corners. The light and delicate design is highlighted by the thickness of the ceramic: only 6 mm, perfectly resistant.

Altino est un lavabo rectangulaire à poser, aux angles doux et arrondis. Le design léger et délicat est valorisé par l'épaisseur de la céramique: seulement 6 mm, parfaitement résistante.

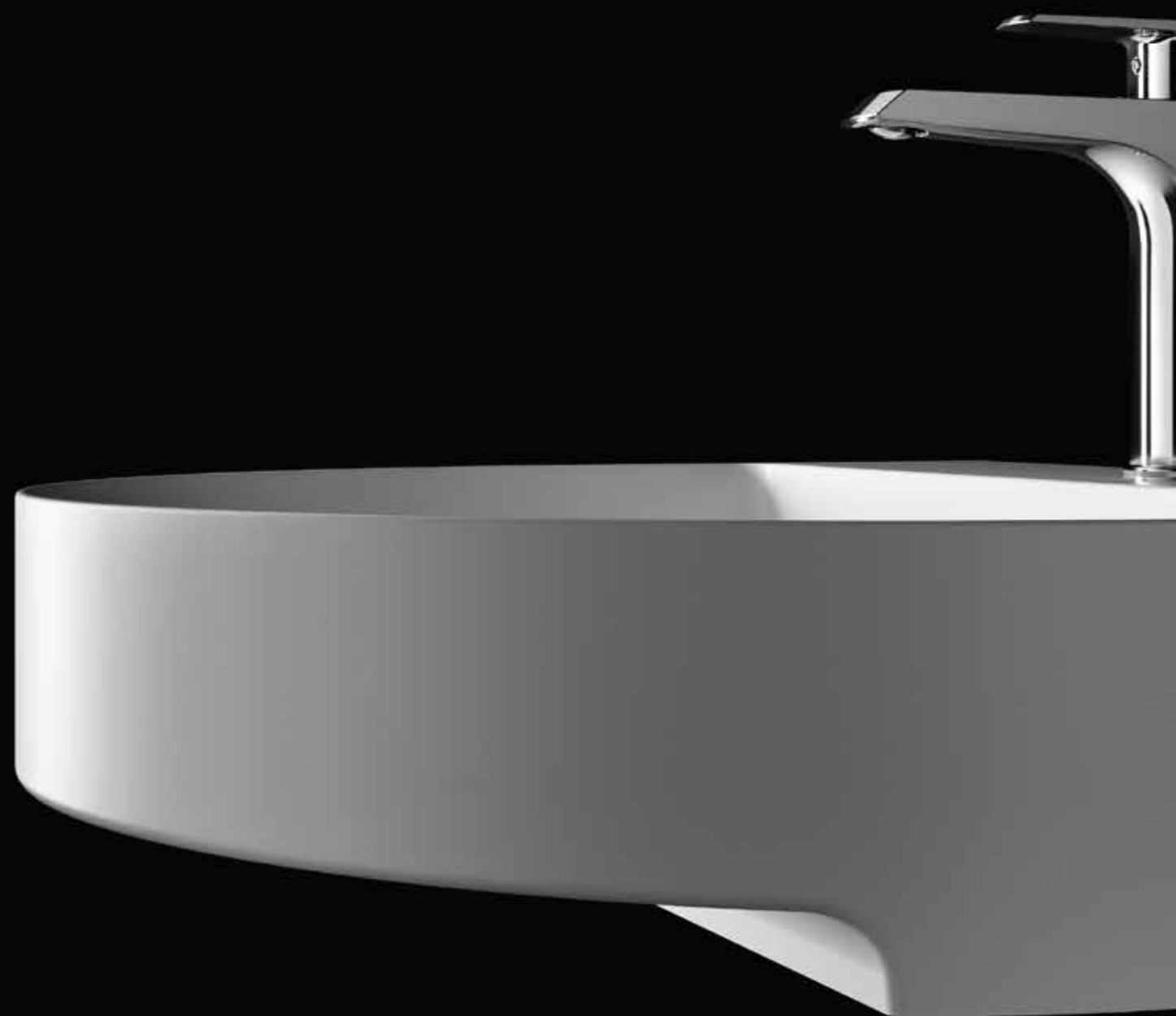

ARKO

Lavabo da appoggio e a parete
Countertop and wall-hung washbasin - Lavabo à poser et au mur

Arko, come il nome, è un lavabo da appoggio che descrive un arco perfetto. Le sue linee classicheggianti sono state rivisitate per inserirsi anche nei contesti più moderni: l'interno è spigoloso, netto, mentre l'esterno è morbido e armonioso.

La sua forma, ampia e generosa, supera i confini rigidi del top ed esce dagli schemi imposti.

Arko, like its name, is a countertop washbasin that describes a perfect arch. Its classical lines have been revisited to fit into more modern contexts: the interior is angular, while the exterior is soft and harmonious. Its shape, wide and generous, overcomes the rigid boundaries of the top and breaks the imposed mould.

Arko, comme son nom, est un lavabo de comptoir qui décrit un arc parfait. Ses lignes classiques ont été revisitées pour s'adapter à des contextes plus modernes : l'intérieur est anguleux, tandis que l'extérieur est doux et harmonieux. Sa forme, large et généreuse, dépasse les limites du plan de toilette et sort des schémas imposés.



► Lavabo Arko - colore bianco opaco
Washbasin, matt white colour - Lavabo, couleur blanc mat





► Lavabo Arko - colore sabbia opaco
Washbasin, matt sand colour - Lavabo, couleur sable mat



VIGNO

Freestanding

Vigno è un lavabo freestanding dal design unico nel suo genere, destinato a diventare iconico. È composto da due blocchi: una colonna statuaria alla base, che sorregge il lavabo circolare nella parte superiore. Completamento realizzato in ceramica si inserisce perfettamente in ambienti sofisticati ed eleganti.

Vigno is a freestanding washbasin with a unique design, meant to become iconic. It consists of two blocks: a statuesque column at the base, supporting the circular washbasin at the top. Completely made of ceramic, it fits perfectly into sophisticated and elegant environments.

Vigno est un lavabo autoportant au design unique, destiné à devenir iconique. Il se compose de deux blocs: une colonne statuaire à la base, qui soutient le lavabo circulaire au sommet. Réalisé en céramique, il s'intègre parfaitement dans des environnements sophistiqués et élégants.



Lavabo Vigno - 48x87H
Washbasin - Lavabo



Un design sofisticato che si fonde con la praticità: la particolare curva interna del lavabo è stata appositamente studiata per contenere eventuali gocce di rimbalzo.

Sophisticated design blends with practicality: the special inner curve of the washbasin has been specially created to contain any bouncing drops.

Un design sophistiqué et pratique: la courbe intérieure du lavabo est conçue pour retenir les gouttes d'eau.



Dettagli distintivi

Distinctive details - Détails distinctifs

Per un bagno dallo stile sofisticato, Vigno è disponibile nelle varie colorazioni. Il colore accentua il suo design distintivo e lo rende protagonista dell'ambiente bagno.

For a bathroom with a sophisticated style, Vigno is also available in several tones. The colour underlines its distinctive design and makes it the centrepiece of the bathroom environment.

Pour une salle de bains au style sophistiqué, Vigno est disponible en plusieurs coloris. La couleur accentue son design unique et en fait le protagoniste de la salle de bains.





Lavabo Vigno a parete - 48x87H
 Washbasin with wall installation - Lavabo avec fixation murale



► **Lavabo Vigno - colore sabbia opaco - 48x87H**
Washbasin, matt sand colour - Lavabo couleur sable mat





VERA

Consolle L 72-92-107-122-142 cm

Linee nette e rigorose e un design che va all'essenza delle cose: il lavabo consolle Vera ha una bellezza minimale, curata nel dettaglio. Così curata da rendere affascinante anche un'installazione a muro che lascia intravedere le sue componenti tecniche. Vera è una scelta audace ed essenziale allo stesso tempo, sinonimo di carattere deciso.

Clear, rigorous lines and a design that gets to the essence of things: the Vera console washbasin has a minimalist beauty, with attention to detail.

So meticulous that even a wall installation that reveals its technical components is fascinating. Vera is a bold and essential choice at the same time, synonymous with decisive character.

Des lignes claires et rigoureuses, un design essentiel: le lavabo consolle Vera est d'une beauté minimaliste, traitée en détail. Si minutieux que même ses composants techniques sont fascinants. Vera est un choix à la fois audacieux et essentiel, synonyme de caractère décisif.



Design versatile

Versatile design - Un design polyvalent

Adattare Vera al proprio ambiente e al proprio stile è semplice, grazie a un'ampia varietà di dimensioni standard ai vari colori.

Adapting Vera to your environment and style is easy, thanks to a wide variety of standard sizes and colours.

Il est facile d'adapter Vera à votre environnement et à votre style, grâce à une grande variété de tailles et de couleurs standard.



Consolle Vera L 72 ceramica
Ceramic - Céramique



Consolle Vera L 92 ceramica
Ceramic - Céramique



Consolle Vera L 107 ceramica
Ceramic - Céramique



Consolle Vera L 122 ceramica
Ceramic - Céramique



Consolle Vera L 142 ceramica
Ceramic - Céramique





► **Consolle Vera L 122 - colore nero**
 Vera console black colour - Console Vera, couleur noir





► **Consolle Vera L 92 - colore sabbia**
 Vera console sand colour - Console Vera, couleur sable



Consolle Vera L 92 - colore oceano
 Vera console ocean colour - Console Vera, couleur ocean



La consolle Vera può essere installata nelle basi lavabo della collezione arredobagno Geromin.

Vera console can be installed in the washbasin bases of the Geromin bathroom collection.

La console Vera peut être installée dans les meubles bas de la collection de salles de bains Geromin.





Il lavabo doppio da 142 cm offre tanto spazio per rendere più confortevole la vita quotidiana.

The 142 cm double washbasin offers plenty of space to make everyday life more comfortable.

Le double lavabo de 142 cm offre un grand espace qui rend la vie quotidienne plus confortable.

Listino prezzi

Price List - Liste de prix

Sanitari

Sanitaryware - Sanitaires

- 120 **Avigo**
- 122 **Fio**
- 124 **Stino**
- 126 **Voga**

Lavabi

Washbasins - Lavabos

- 130 **Avigo**
- 132 **Albo**
- 133 **Altino**
- 134 **Arko**
- 135 **Vigno**
- 136 **Vera**

142 Espositore sanitari

Sanitaryware display stand
Vitrine de présentation pour articles sanitaires

143 Accessori

Accessories - Accessoires

148 Ricambi

Spare parts - Pièces détachées

Vasche

Bathtubs - Baignoires

- 152 **Avigo**
- 153 **Fio**

154 Finiture

Finishes - Finitions

157 Condizioni generali di vendita

General terms and conditions of sale
Conditions générales de vente

Sanitari

Avigo

Pag. 120

Vasi e Bidet sospesi

Wall-hung WCs and bidets - WC et bidets suspendus

56x36
Cod. 0K0110010



56x36
Cod. 0K0120010



Vasi e Bidet a terra

Ground-installed WCs and bidets - WC et bidets au sol

56x36
Cod. 0K0110020



56x36
Cod. 0K0120020



Fio

Pag. 122

Vasi e Bidet sospesi

Wall-hung WCs and bidets - WC et bidets suspendus

55x36
Cod. 0K0210010



55x36
Cod. 0K0220010



Vasi e Bidet a terra

Ground-installed WCs and bidets - WC et bidets au sol

55x36
Cod. 0K0210020



55x36
Cod. 0K0220020



Sanitari

Stino

Pag. 124

Vasi e Bidet sospesi

Wall-hung WCs and bidets - WC et bidets suspendus

52x36
Cod. 0K0310010



52x36
Cod. 0K0320010



Vasi e Bidet a terra

Ground-installed WCs and bidets - WC et bidets au sol

52x36
Cod. 0K0310020



52x36
Cod. 0K0320020



Voga

Pag. 126

Vasi e Bidet sospesi

Wall-hung WCs and bidets - WC et bidets suspendus

54x36
Cod. 0K0410010



54x36
Cod. 0K0420010



Colori disponibili

Available colours - Couleurs disponibles

007	006	063	062	036
Bianco lucido Glossy White - Blanc brillant	Bianco opaco Matt White - Blanc mat	Sabbia opaco Matt Sand - Sable mat	Grigio opaco Matt Grey - Gris mat	Nero opaco Matt Black - Noir mat

Avigo vaso

Vaso sospeso - Wall-hung WC - WC suspendu



56 x 36 x H 34,2 cm

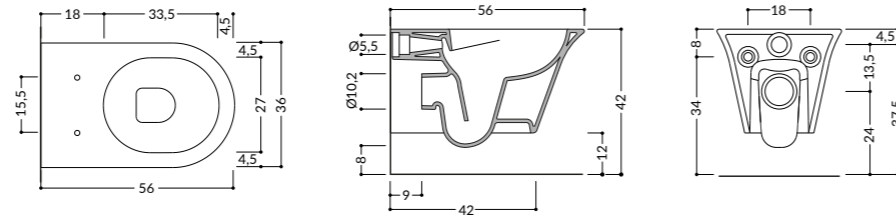

Descrizione - Description

- Vaso sospeso rimless completo di sistema di fissaggio (invisible) e riduttore di flusso regolabile · Installazione filo parete
- Rimless wall-hung WC complete with fixing system (invisible) and adjustable flow reducer
- Flush-to-wall installation
- WC suspendu sans rebord, complet avec système de fixation (invisible) et réducteur de débit réglable · Installation affleurante au mur

- N.B. coprivaso non incluso nel prezzo
- Note: seat cover not included in the price · Remarque: La siège n'est pas incluse dans le prix

Kg 22 - Q.ta pallet pcs. 15

Codice - Code	EURO		
	Bianco lucido Glossy White Blanc brillant	Bianco opaco Matt White Blanc mat	Colorato opaco Matt Coloured Couleur mate
0K0110010	450	675	675
	007	006	063 062 036

Vaso a terra - Ground-installed WC - WC au sol



56 x 36 x H 42 cm

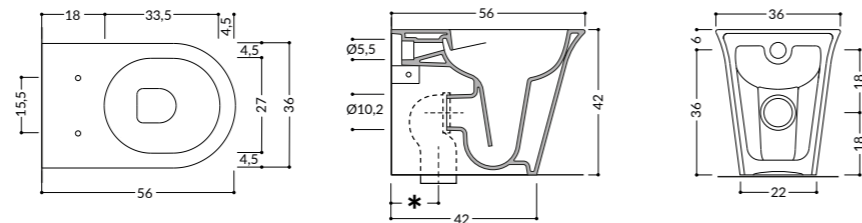

Descrizione - Description

- Vaso a terra rimless completo di sistema di fissaggio (invisible) e riduttore di flusso regolabile
- Installazione filo parete
- Rimless ground-installed WC complete with fixing system (invisible) and adjustable flow reducer · Flush-to-wall installation
- WC au sol sans rebord complet avec système de fixation (invisible) et réducteur de débit réglable · Installation affleurante au mur

- N.B. coprivaso non incluso nel prezzo
- Note: seat cover not included in the price · Remarque: La siège n'est pas incluse dans le prix

Kg 24,5 - Q.ta pallet pcs. 15

* Curva tecnica - Pan connector - Connecteur

0K9920070 da 130 a 160 mm
0K9920080 da 160 a 190 mm
0K9920090 da 60 a 130 mm

Codice - Code	EURO		
	Bianco lucido Glossy White Blanc brillant	Bianco opaco Matt White Blanc mat	Colorato opaco Matt Coloured Couleur mate
0K0110020	450	675	675
	007	006	063 062 036

Coprivaso - Seat cover - Siège



46 x 36 cm

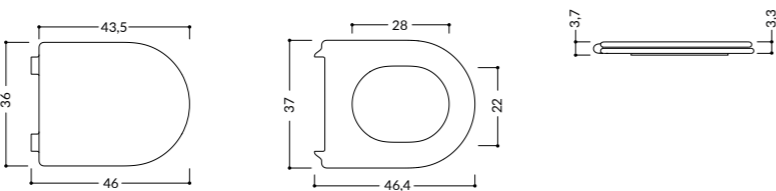

Descrizione - Description

- Coprivaso in termoindurente completo di soft close e sgancio rapido
- Complete thermosetting seat cover soft close and quick release
- Siège en thermodurcissable avec fermeture ralentie et ouverture rapide

Kg 3,5 - Q.ta pallet pcs. 15

Codice - Code	EURO		
	Bianco lucido Glossy White Blanc brillant	Bianco opaco Matt White Blanc mat	Colorato opaco Matt Coloured Couleur mate
0K0130010	158	263	263
	007	006	063 062 036

- Per curve tecniche e accessori vedi pag. 146
- For pan connectors and accessories see page 146
- Pour les connecteurs et les accessoires, voir page 146

Avigo bidet

Bidet sospeso - Wall-hung Bidet - Bidet suspendu



56 x 36 x H 30 cm

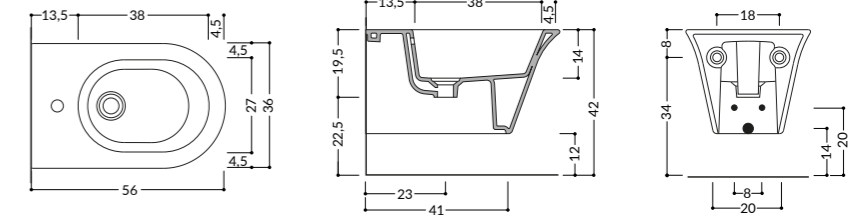

Descrizione - Description

- Bidet sospeso completo di sistema di fissaggio (invisible) · Installazione filo parete
- Wall-hung bidet complete with fixing system (invisible) · Flush-to-wall installation
- Bidet suspendu complet avec système de fixation (invisible) · Installation affleurante au mur

Kg 19 - Q.ta pallet pcs. 15

Codice - Code	EURO		
	Bianco lucido Glossy White Blanc brillant	Bianco opaco Matt White Blanc mat	Colorato opaco Matt Coloured Couleur mate
0K0120010	450	675	675
	007	006	063 062 036

Bidet a terra - Ground-installed Bidet - Bidet au sol



56 x 36 x H 42 cm

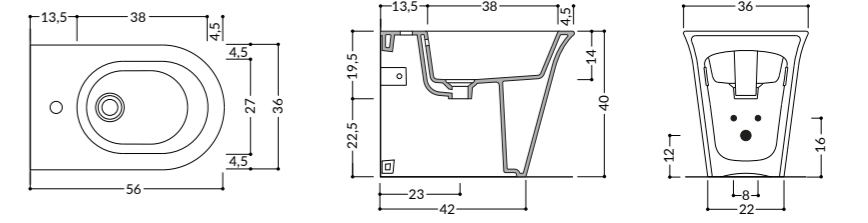

Descrizione - Description

- Bidet a terra completo di sistema di fissaggio (invisible) · Installazione filo parete
- Ground-installed bidet complete with fixing system (invisible) · Flush-to-wall installation
- Bidet au sol complet avec système de fixation (invisible) · Installation affleurante au mur

Kg 22 - Q.ta pallet pcs. 15

Codice - Code	EURO		
	Bianco lucido Glossy White Blanc brillant	Bianco opaco Matt White Blanc mat	Colorato opaco Matt Coloured Couleur mate
0K0120020	450	675	675
	007	006	063 062 036

Piletta - Drain plug - Bonde



- Piletta a scarico libero con tappo in ceramica
- Free-flowing drain plug with ceramic cap
- Bonde de vidange libre avec bouchon en céramique

Kg 0,5

Codice - Code	EURO		
	Bianco lucido Glossy White Blanc brillant	Bianco opaco Matt White Blanc mat	Colorato opaco Matt Coloured Couleur mate
0K9920060	80		
	007	006	063 062 036



- Piletta pop-up Ø 4,5 cm
- Pop-up drain plug Ø 4,5 cm
- Bonde pop-up Ø 4,5 cm

Kg 0,5

Codice - Code	EURO			
	Cromo Chrome Chrome	Nero Black Noir	Rosa Pink Rose	Acciaio Steel Acier
00PFP	31	53	94	101

Fio vaso

Vaso sospeso - Wall-hung WC - WC suspendu



55 x 36 x H 34,2 cm

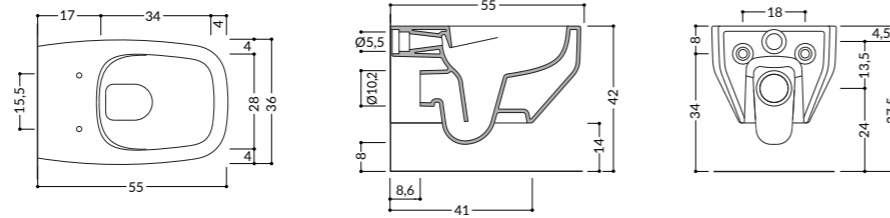

Descrizione - Description

- Vaso sospeso rimless completo di sistema di fissaggio (invisible) e riduttore di flusso regolabile · Installazione filo parete
- Rimless wall-hung WC complete with fixing system (invisible) and adjustable flow reducer · Flush-to-wall installation
- WC suspendu sans rebord, complet avec système de fixation (invisible) et réducteur de débit réglable · Installation affleurante au mur

- N.B. coprivaso non incluso nel prezzo
- Note: seat cover not included in the price · Remarque: La siège n'est pas incluse dans le prix

Kg 21,5 - Q.ta pallet pcs. 15

Codice - Code	EURO		
	Bianco lucido Glossy White Blanc brillant	Bianco opaco Matt White Blanc mat	Colorato opaco Matt Coloured Couleur mate
0K0210010	370	615	615
	007	006	063 062 036

Vaso a terra - Ground-installed WC - WC au sol



55 x 36 x H 42 cm

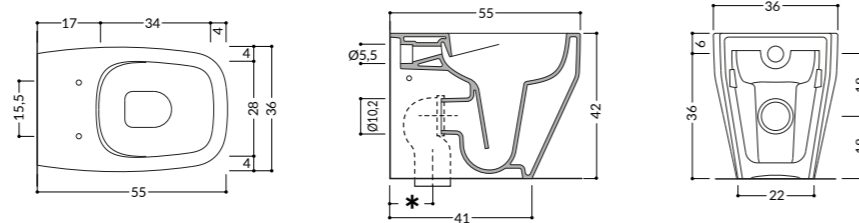

Descrizione - Description

- Vaso a terra rimless completo di sistema di fissaggio (invisible) e riduttore di flusso regolabile
- Installazione filo parete
- Rimless ground-installed WC complete with fixing system (invisible) and adjustable flow reducer · Flush-to-wall installation
- WC au sol sans rebord complet avec système de fixation (invisible) et réducteur de débit réglable · Installation affleurante au mur

- N.B. coprivaso non incluso nel prezzo
- Note: seat cover not included in the price · Remarque: La siège n'est pas incluse dans le prix

Kg 29 - Q.ta pallet pcs. 15

* Curva tecnica - Pan connector - Connecteur

- 0K9920070 da 130 a 160 mm
- 0K9920080 da 160 a 190 mm
- 0K9920090 da 60 a 130 mm

Codice - Code	EURO		
	Bianco lucido Glossy White Blanc brillant	Bianco opaco Matt White Blanc mat	Colorato opaco Matt Coloured Couleur mate
0K0210020	370	615	615
	007	006	063 062 036

Coprivaso - Seat cover - Siège



45 x 37 cm

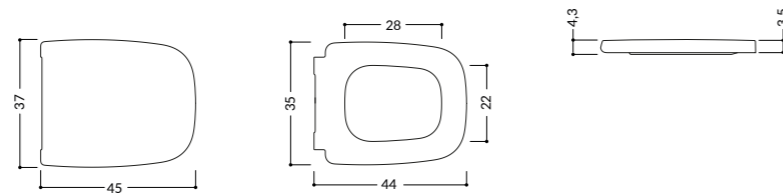

Descrizione - Description

- Coprivaso in termoindurente completo di soft close e sgancio rapido
- Complete thermosetting seat cover soft close and quick release
- Siège en thermodurcissable avec fermeture ralentie et ouverture rapide

Kg 3,5 - Q.ta pallet pcs. 15

- Per curve tecniche e accessori vedi pag. 146
- For pan connectors and accessories see page 146
- Pour les connecteurs et les accessoires, voir page 146

Codice - Code	EURO		
	Bianco lucido Glossy White Blanc brillant	Bianco opaco Matt White Blanc mat	Colorato opaco Matt Coloured Couleur mate
0K0230010	145	250	250
	007	006	063 062 036

Fio bidet

Bidet sospeso - Wall-hung Bidet - Bidet suspendu



55 x 36 x H 28 cm

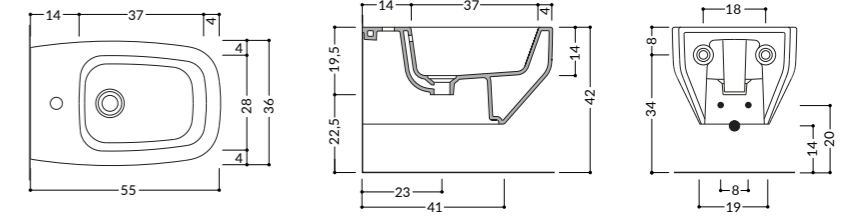

Descrizione - Description

- Bidet sospeso completo di sistema di fissaggio (invisible) · Installazione filo parete
- Wall-hung bidet complete with fixing system (invisible) · Flush-to-wall installation
- Bidet suspendu complet avec système de fixation (invisible) · Installation affleurante au mur

Kg 19 - Q.ta pallet pcs. 15

Codice - Code	EURO		
	Bianco lucido Glossy White Blanc brillant	Bianco opaco Matt White Blanc mat	Colorato opaco Matt Coloured Couleur mate
0K0220010	370	615	615
	007	006	063 062 036

Bidet a terra - Ground-installed Bidet - Bidet au sol



55 x 36 x H 42 cm

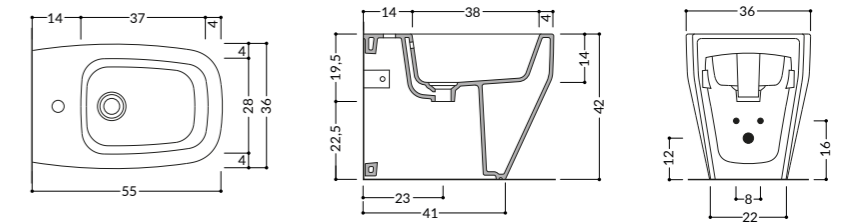

Descrizione - Description

- Bidet a terra completo di sistema di fissaggio (invisible) · Installazione filo parete
- Ground-installed bidet complete with fixing system (invisible) · Flush-to-wall installation
- Bidet au sol complet avec système de fixation (invisible) · Installation affleurante au mur

Kg 24 - Q.ta pallet pcs. 15

Codice - Code	EURO		
	Bianco lucido Glossy White Blanc brillant	Bianco opaco Matt White Blanc mat	Colorato opaco Matt Coloured Couleur mate
0K0220020	370	615	615
	007	006	063 062 036

Piletta - Drain plug - Bonde



- Piletta a scarico libero con tappo in ceramica
- Free-flowing drain plug with ceramic cap
- Bonde de vidange libre avec bouchon en céramique

Kg 0,5

Codice - Code	EURO		
	Bianco lucido Glossy White Blanc brillant	Bianco opaco Matt White Blanc mat	Colorato opaco Matt Coloured Couleur mate
0K9920060	80		
	007	006	063 062 036



- Piletta pop-up Ø 4,5 cm
- Pop-up drain plug Ø 4,5 cm
- Bonde pop-up Ø 4,5 cm

Kg 0,5

Codice - Code	EURO			
	Cromo Chrome Chrome	Nero Black Noir	Rosa Pink Rose	Acciaio Steel Acier
00PFP	31	53	94	101

Stino vaso

Vaso sospeso - Wall-hung WC - WC suspendu



52 x 36 x H 34,2 cm

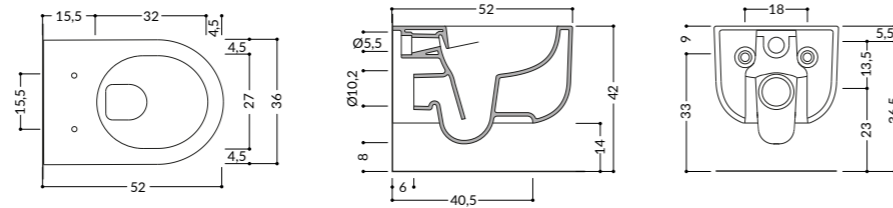

Descrizione - Description

- Vaso sospeso rimless completo di sistema di fissaggio (invisible) e riduttore di flusso regolabile · Installazione filo parete
- Rimless wall-hung WC complete with fixing system (invisible) and adjustable flow reducer
- Flush-to-wall installation
- WC suspendu sans rebord, complet avec système de fixation (invisible) et réducteur de débit réglable · Installation affleurante au mur

- N.B. coprivaso non incluso nel prezzo
- Note: seat cover not included in the price · Remarque: La siège n'est pas incluse dans le prix

Kg 23 - Q.ta pallet pcs. 15

Codice - Code	EURO		
	Bianco lucido Glossy White Blanc brillant	Bianco opaco Matt White Blanc mat	Colorato opaco Matt Coloured Couleur mate
0K0310010	335	555	555
	007	006	063 062 036

Vaso a terra - Ground-installed WC - WC au sol



52 x 36 x H 40 cm

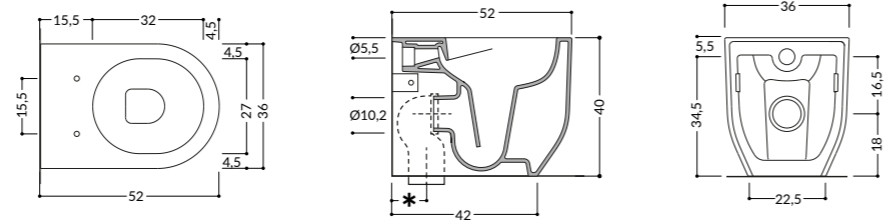

Descrizione - Description

- Vaso a terra rimless completo di sistema di fissaggio (invisible) e riduttore di flusso regolabile
- Installazione filo parete
- Rimless ground-installed WC complete with fixing system (invisible) and adjustable flow reducer · Flush-to-wall installation
- WC au sol sans rebord complet avec système de fixation (invisible) et réducteur de débit réglable · Installation affleurante au mur

- N.B. coprivaso non incluso nel prezzo
- Note: seat cover not included in the price · Remarque: La siège n'est pas incluse dans le prix

Kg 26 - Q.ta pallet pcs. 15

* Curva tecnica - Pan connector - Connecteur

- 0K9920070 da 110 a 140 mm
- 0K9920080 da 160 mm
- 0K9920090 da 90 a 110 mm

Codice - Code	EURO		
	Bianco lucido Glossy White Blanc brillant	Bianco opaco Matt White Blanc mat	Colorato opaco Matt Coloured Couleur mate
0K0310020	335	555	555
	007	006	063 062 036

Coprivaso - Seat cover - Siège



45 x 37 cm

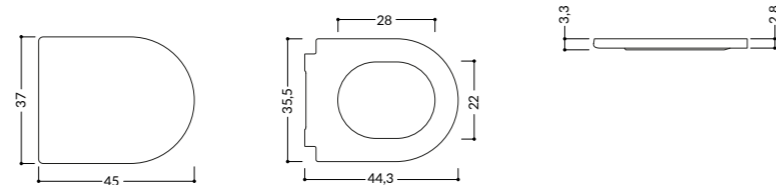

Descrizione - Description

- Coprivaso in termoindurente completo di soft close e sgancio rapido
- Complete thermosetting seat cover soft close and quick release
- Siège en thermodurcissable avec fermeture ralentie et ouverture rapide

Kg 3,5 - Q.ta pallet pcs. 15

- Per curve tecniche e accessori vedi pag. 146
- For pan connectors and accessories see page 146
- Pour les connecteurs et les accessoires, voir page 146

Codice - Code	EURO		
	Bianco lucido Glossy White Blanc brillant	Bianco opaco Matt White Blanc mat	Colorato opaco Matt Coloured Couleur mate
0K0330010	145	250	250
	007	006	063 062 036

Stino bidet

Bidet sospeso - Wall-hung Bidet - Bidet suspendu



52 x 36 x H 27,5 cm

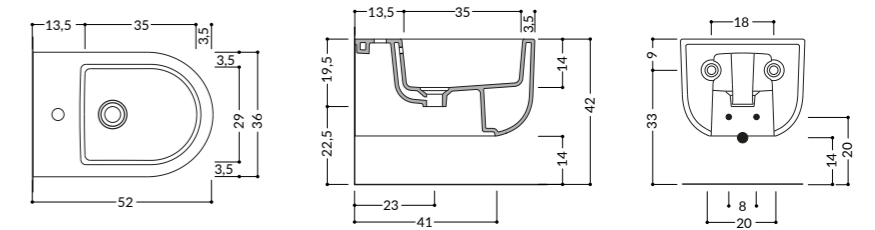

Descrizione - Description

- Bidet sospeso completo di sistema di fissaggio (invisible) · Installazione filo parete
- Wall-hung bidet complete with fixing system (invisible) · Flush-to-wall installation
- Bidet suspendu complet avec système de fixation (invisible) · Installation affleurante au mur

Kg 20 - Q.ta pallet pcs. 15

Codice - Code	EURO		
	Bianco lucido Glossy White Blanc brillant	Bianco opaco Matt White Blanc mat	Colorato opaco Matt Coloured Couleur mate
0K0320010	335	555	555
	007	006	063 062 036

Bidet a terra - Ground-installed Bidet - Bidet au sol



52 x 36 x H 40 cm

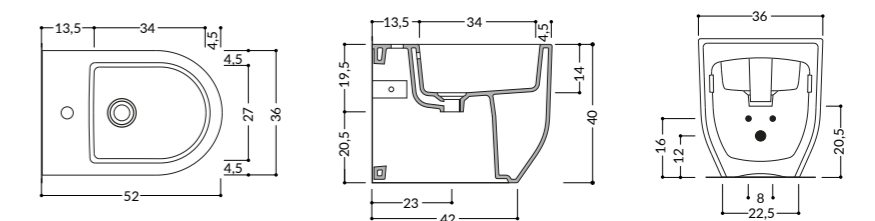

Descrizione - Description

- Bidet a terra completo di sistema di fissaggio (invisible) · Installazione filo parete
- Ground-installed bidet complete with fixing system (invisible) · Flush-to-wall installation
- Bidet au sol complet avec système de fixation (invisible) · Installation affleurante au mur

Kg 25 - Q.ta pallet pcs. 15

Codice - Code	EURO		
	Bianco lucido Glossy White Blanc brillant	Bianco opaco Matt White Blanc mat	Colorato opaco Matt Coloured Couleur mate
0K0320020	335	555	555
	007	006	063 062 036

Piletta - Drain plug - Bonde



- Piletta a scarico libero con tappo in ceramica
- Free-flowing drain plug with ceramic cap
- Bonde de vidange libre avec bouchon en céramique

Kg 0,5

Codice - Code	EURO		
	Bianco lucido Glossy White Blanc brillant	Bianco opaco Matt White Blanc mat	Colorato opaco Matt Coloured Couleur mate
0K9920060	80		
	007	006	063 062 036



- Piletta pop-up Ø 4,5 cm
- Pop-up drain plug Ø 4,5 cm
- Bonde pop-up Ø 4,5 cm

Kg 0,5

Codice - Code	EURO			
	Cromo Chrome Chrome	Nero Black Noir	Rosa Pink Rose	Acciaio Steel Acier
00PFP	31	53	94	101

Voga vaso

Vaso sospeso - Wall-hung WC - WC suspendu



54 x 36 x H 34,5 cm

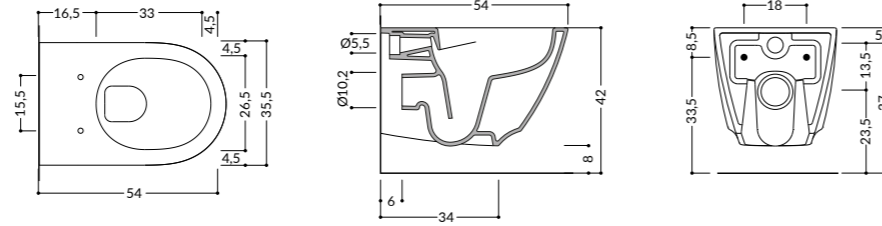

Descrizione - Description

- Vaso sospeso rimless completo di sistema di fissaggio (ultra rapido) e riduttore di flusso regolabile · Installazione filo parete
- Rimless wall-hung WC complete with (ultra-rapid) fixing system and adjustable flow reducer
- Flus-to-wall installation
- WC suspendu sans rebord, complet avec système de fixation (ultra-rapide) et réducteur de débit réglable · Installation affleurante au mur

- N.B. coprivaso non incluso nel prezzo
- Note: seat cover not included in the price · Remarque: La siège n'est pas incluse dans le prix

Kg 21 - Q.ta pallet pcs. 15

Codice - Code	EURO		
	Bianco lucido Glossy White Blanc brillant	Bianco opaco Matt White Blanc mat	Colorato opaco Matt Coloured Couleur mate
0K0410010	390	585	585
	007	006	063 062 036

Coprivaso - Seat cover - Siège



44 x 36 cm

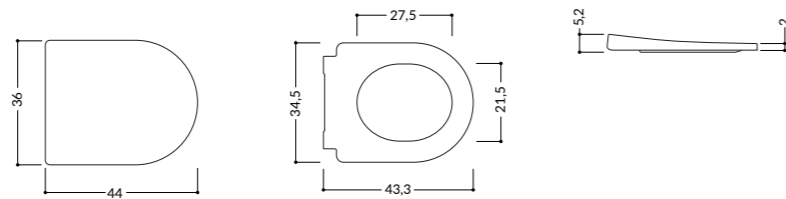

Descrizione - Description

- Coprivaso in termoindurente completo di soft close e sgancio rapido
- Complete thermosetting seat cover soft close and quick release
- Siège en thermodurcissable avec fermeture ralentie et ouverture rapide

Kg 3,5 - Q.ta pallet pcs. 15

- Per curve tecniche e accessori vedi pag. 146
- For pan connectors and accessories see page 146
- Pour les connecteurs et les accessoires, voir page 146

Codice - Code	EURO		
	Bianco lucido Glossy White Blanc brillant	Bianco opaco Matt White Blanc mat	Colorato opaco Matt Coloured Couleur mate
0K0430010	145	250	250
	007	006	063 062 036

Voga bidet

Bidet sospeso - Wall-hung Bidet - Bidet suspendu



54 x 36 x H 34,5 cm

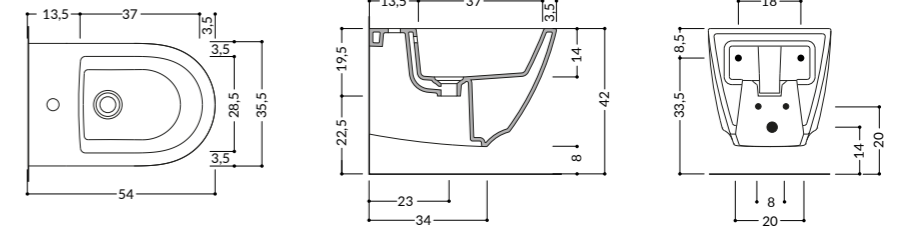

Descrizione - Description

- Bidet sospeso completo di sistema di fissaggio (ultra rapido) · Installazione filo parete
- Wall-hung bidet complete with (ultra-rapid) fixing system · Flush-to-wall installation
- Bidet suspendu complet avec système de fixation (ultra-rapide)
- Installation affleurante au mur

Kg 19 - Q.ta pallet pcs. 15

Codice - Code	EURO		
	Bianco lucido Glossy White Blanc brillant	Bianco opaco Matt White Blanc mat	Colorato opaco Matt Coloured Couleur mate
0K0420010	390	585	585
	007	006	063 062 036

Piletta - Drain plug - Bonde



- Piletta a scarico libero con tappo in ceramica
- Free-flowing drain plug with ceramic cap
- Bonde de vidange libre avec bouchon en céramique

Kg 0,5

Codice - Code	EURO		
	Bianco lucido Glossy White Blanc brillant	Bianco opaco Matt White Blanc mat	Colorato opaco Matt Coloured Couleur mate
0K9920060	80		
	007	006	063 062 036



- Piletta pop-up Ø 4,5 cm
- Pop-up drain plug Ø 4,5 cm
- Bonde pop-up Ø 4,5 cm

Kg 0,5

Codice - Code	EURO			
	Cromo Chrome Chrome	Nero Black Noir	Rosa Pink Rose	Acciaio Steel Acier
00PFP	31	53	94	101

Lavabi

Avigo

Pag. 130

Lavabo da appoggio

Countertop washbasin - Lavabo à poser

67x45
Cod. 0K0140010



60x39
Cod. 0K0140030



Ø 39
Cod. 0K0140020



Albo

Pag. 132

Lavabo da appoggio

Countertop washbasin - Lavabo à poser

65x39
Cod. 0K0610010



Altino

Pag. 133

Lavabo da appoggio

Countertop washbasin - Lavabo à poser

60x35
Cod. 0K0710010



Arko

Pag. 134

Lavabo da appoggio e parete

Countertop and wall-hung washbasin - Lavabo à poser et au mur

Appoggio
60x51
Cod. 0K0910010



Lavabi

Vigno Freestanding

Pag. 135

Lavabo freestanding

Freestanding washbasin - Lavabo autoportante

A pavimento
Ground-installed - Sur
pied
Ø48x87
Cod. 0K0510020



A parete
Wall-hung - Au mur
Ø48x87
Cod. 0K0510010



Vera Consolle

Pag. 136

Consolle a parete / da appoggio / con struttura

Console with structure / wall-hung / countertop - Console avec structure / au mur / à poser

72x51
Cod. 0K0810010



92x51
Cod. 0K0810020



107x51
Cod. 0K0810030



122x51
Cod. 0K0810040



142x51
Cod. 0K0810050



Colori disponibili

Available colours - Couleurs disponibles



Bianco lucido
Glossy White - Blanc brillant

Bianco opaco
Matt White - Blanc mat

Sabbia opaco
Matt Sand - Sable mat

Grigio opaco
Matt Grey - Gris mat

Nero opaco
Matt Black - Noir mat

Avigo lavabo



Ø 39 cm



67x45 cm



60x39 cm

Avigo lavabo

Lavabo Ø 39 cm - Washbasin - Lavabo



Ø 39 x H 11 cm

Descrizione - Description

- Lavabo installazione da appoggio · Senza troppopieno
- Countertop installation washbasin · Without overflow
- Lavabo à poser · Sans trop-plein

Kg 6,5

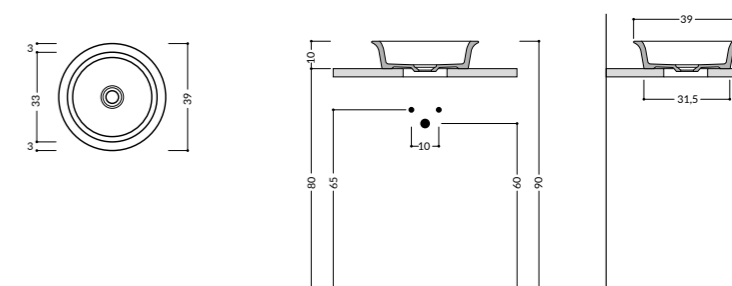

Codice - Code	EURO		
	Bianco lucido Glossy White Blanc brillant	Bianco opaco Matt White Blanc mat	Colorato opaco Matt Coloured Couleur mate
OK0140020	296	444	444
	007	006	063 062 036

Lavabo 60x39 cm - Washbasin - Lavabo



60 x 39 x H 11 cm

Descrizione - Description

- Lavabo installazione da appoggio · Senza troppopieno
- Countertop installation washbasin · Without overflow
- Lavabo à poser · Sans trop-plein

Kg 9,5

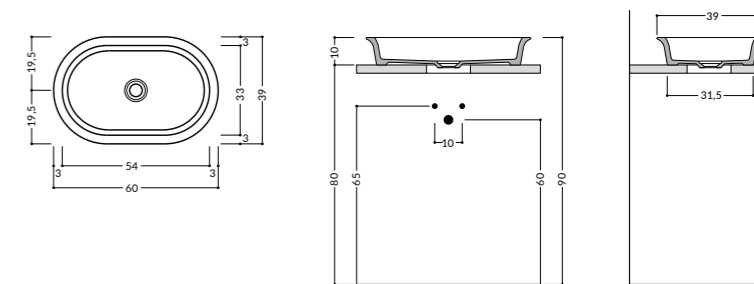

Codice - Code	EURO		
	Bianco lucido Glossy White Blanc brillant	Bianco opaco Matt White Blanc mat	Colorato opaco Matt Coloured Couleur mate
OK0140030	318	478	478
	007	006	063 062 036

Lavabo 67x45 cm - Washbasin - Lavabo



67 x 45 x H 10 cm

Descrizione - Description

- Lavabo installazione da appoggio · Senza troppopieno
- Countertop installation washbasin · Without overflow
- Lavabo à poser · Sans trop-plein

Kg 12,5

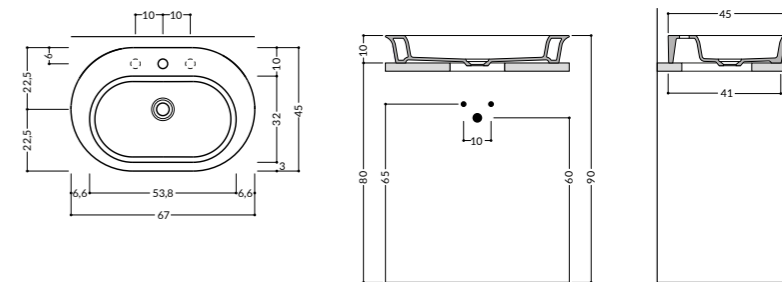

Codice - Code	EURO		
	Bianco lucido Glossy White Blanc brillant	Bianco opaco Matt White Blanc mat	Colorato opaco Matt Coloured Couleur mate
OK0140010	330	494	494
	007	006	063 062 036

Albo lavabo



Lavabo 65x39 cm - Washbasin - Lavabo



65 x 39 x H 12 cm

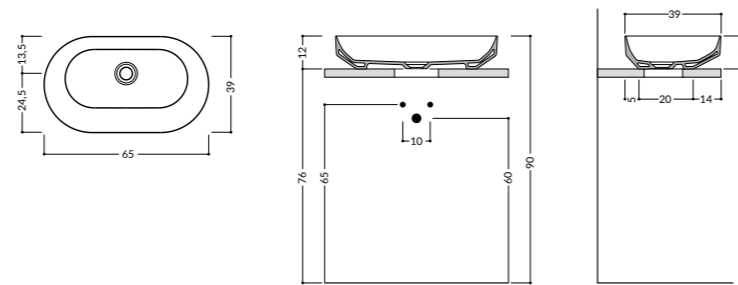

Descrizione - Description

- Lavabo installazione da appoggio • Senza troppopieno
- Countertop installation washbasin • Without overflow
- Lavabo à poser • Sans trop-plein

Kg 11

Codice - Code	EURO		
	Bianco lucido Glossy White Blanc brillant	Bianco opaco Matt White Blanc mat	Colorato opaco Matt Coloured Couleur mate
OK0610010	325	487	487
	007	006	063 062 036

Altino lavabo



Lavabo 60x35 cm - Washbasin - Lavabo



60 x 35 x H 12/14 cm

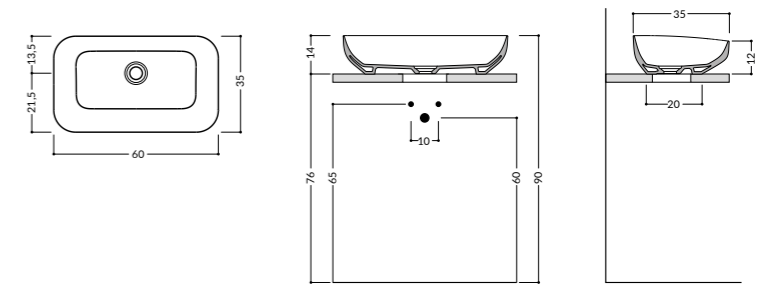

Descrizione - Description

- Lavabo installazione da appoggio • Senza troppopieno
- Countertop installation washbasin • Without overflow
- Lavabo à poser • Sans trop-plein

Kg 11,5

Codice - Code	EURO		
	Bianco lucido Glossy White Blanc brillant	Bianco opaco Matt White Blanc mat	Colorato opaco Matt Coloured Couleur mate
OK0710010	335	498	498
	007	006	063 062 036

Arko lavabo



Lavabo 60x51x12H cm - Washbasin - Lavabo

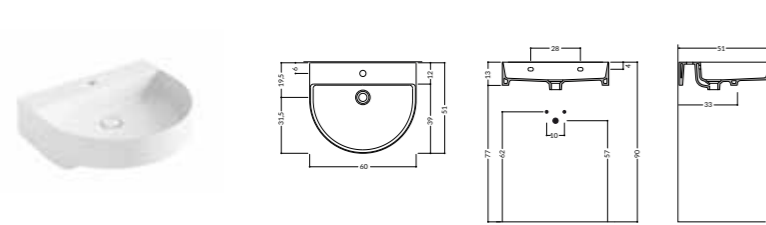

- Lavabo installazione sospesa o da appoggio completo di fissaggi
- Wall-hung or countertop washbasin complete with fixings
- Lavabo suspendu ou à poser complète avec fixations

Kg 14,5

Codice - Code	EURO		
	Bianco lucido Glossy White Blanc brillant	Bianco opaco Matt White Blanc mat	Colorato opaco Opaque colored Couleur mate
OK0910010	483	724	724

007 006 063 062 036

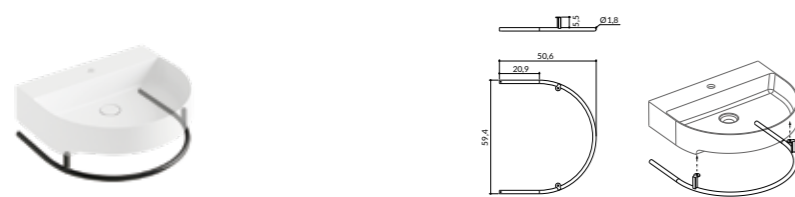

- Porta asciugamani sottolavabo per modello Arko
- Under-sink towel rail for Arko model
- Porte-serviettes sous évier pour le modèle Arko

Codice - Code	EURO	
	Finitura acciaio Steel finish Finition acier	Finitura nero Black finish Finition noire
OK0920010	240	240

Per piletta vedi pag. 143 - For drain plug see page 143 - Pour bonde de vidange voir page 143

Vigno lavabo



Lavabo freestanding Ø48x87H cm - Freestanding washbasin - Lavabo autoportante

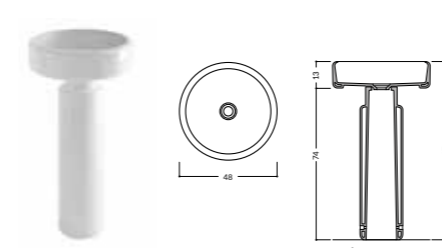

SCARICO A PAVIMENTO
Floor drain - Drain dans le plancher
Kg 29

* Scarico Ø 40 mm da posizionare al centro della colonna - Drain Ø 40 mm to be positioned at the centre of the column - Bonde Ø 40 mm à placer au centre de la colonne

Lavabo freestanding, completo di sistema di scarico e fissaggio a pavimento (senza troppo pieno) - Freestanding washbasin, complete with floor drainage system and floor fixing system (without overflow) - Lavabo autoportante, complet avec système de drainage au sol et fixation au sol (sans trop-plein)

Codice - Code	EURO		
	Bianco lucido Glossy White Blanc brillant	Bianco opaco Matt White Blanc mat	Colorato opaco Opaque colored Couleur mate
OK0510020	1.650	2.360	2.360

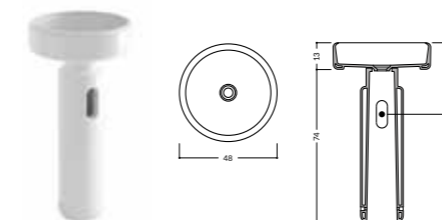

SCARICO A PARETE
Wall drainage - D'écoulement mural
Kg 29

Lavabo freestanding, completo di sistema di scarico a parete e fissaggio a pavimento (senza troppo pieno) - Freestanding washbasin, complete with wall drainage system and floor fixing system (without overflow) - Lavabo autoportante, complet avec système de drainage mural et fixation au sol (sans trop-plein)

Codice - Code	EURO		
	Bianco lucido Glossy White Blanc brillant	Bianco opaco Matt White Blanc mat	Colorato opaco Opaque colored Couleur mate
OK0510010	1.650	2.360	2.360

007 006 063 062 036

Per piletta vedi pag. 143 - For drain plug see page 143 - Pour bonde de vidange voir page 143

Consolle Vera



A parete L 72 - 92 - 107- 122 - 142 cm
Wall-hung console - Console murale



Da appoggio per basi lavabo (vedi listino Bathroom Geromin)
Countertop console, for washbasin bases
Console à poser, pour éléments bas pour lavabo



Mensola
Shelf - Tablette

Struttura
Structure

Con struttura L 72 - 92 - 107- 122 - 142 cm
With structure - Avec structure

Consolle Vera L 72

Lavabo 72x51 cm - Washbasin - Lavabo
72 x 51 x H 11 cm

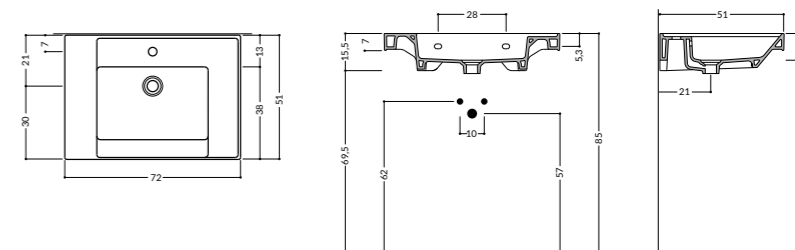

Consolle dimensione fissa, installazione a parete, da appoggio o con struttura, completa di fissaggi - Fixed size console, with structure, wall-hung or countertop installation, complete with fixings - Console de taille fixe, avec structure, installation au mur ou à poser, complète avec fixations

Kg 24

Codice - Code	EURO		
	Bianco lucido Glossy White Blanc brillant	Bianco opaco Matt White Blanc mat	Colorato opaco Matt Coloured Couleur mate
OK0810010	398	546	546
	007	006	063 062 036

Struttura a terra H 79 cm, completa di barra porta asciugamano

Ground-installed structure H 79 cm, complete with towel bar - Structure au sol H 79 cm, complet avec porte-serviettes



Prof. Depth cm	Larg. - Width - Long.	L. Consolle Vera	Codice - Code	EURO	
				Finitura acciaio Steel finish Finition acier	Finitura nero Black finish Finition noire
50	69	72	OK0820010	486	392

Mensola per struttura - Shelf for structure - Tablette pour structure



* Per finiture mensola vedi pag. 154-155
* For shelf finishes see page 154-155
* Pour finitions tablette voir page 154-155

Laccato Bianco White Lacquer Laqué blanc	* Lac. opaco Colorato Matt Col. Lacquer Laq. mate colorée	* Lac. lucido Colorato Glossy Col. Lacquer Lac. Couleur brillante	* Melaminico Melamine Mélamine
--	---	--	--------------------------------------

Prof. Depth cm	Larg. - Width - Long.	L. Consolle Vera	Codice - Code	EURO			
				119	131	162	77
42	73	72	OK0830010				

Piletta - Drain plug - Bonde



• Piletta a scarico libero con tappo in ceramica
• Free-flowing drain plug with ceramic cap
• Bonde de vidange libre avec bouchon en céramique
Kg 0,5

Codice - Code	EURO		
	Bianco lucido Glossy White Blanc brillant	Bianco opaco Matt White Blanc mat	Colorato opaco Matt Coloured Couleur mate
OK9920060	80		
	007	006	063 062 036



• Piletta pop-up Ø 4,5 cm
• Pop-up drain plug Ø 4.5 cm
• Bonde pop-up Ø 4,5 cm
Kg 0,5

Codice - Code	EURO			
	Cromo Chrome Chrome	Nero Black Noir	Rosa Pink Rose	Acciaio Steel Acier
OOPFP	31	53	94	101

Consolle Vera L 92

Lavabo 92x51 cm - Washbasin - Lavabo

92 x 51 x H 11 cm

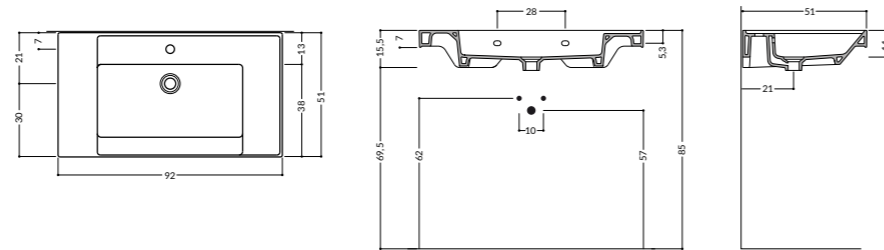

Consolle dimensione fissa, installazione a parete, da appoggio o con struttura, completa di fissaggi - Fixed size console, with structure, wall-hung or countertop installation, complete with fixings - Console de taille fixe, avec structure, installation au mur ou à poser, complète avec fixations

Kg 30,5

Codice - Code	EURO		
	Bianco lucido Glossy White Blanc brillant	Bianco opaco Matt White Blanc mat	Colorato opaco Matt Coloured Couleur mate
OK0810020	522	720	720
	007	006	063 062 036

Struttura a terra H 79 cm, completa di barra porta asciugamano

Ground-installed structure H 79 cm, complete with towel bar - Structure au sol H 79 cm, complet avec porte-serviettes



Prof. Depth cm	Larg. - Width - Long.	L. Consolle Vera	Codice - Code	EURO	
				Finitura acciaio Steel finish Finition acier	Finitura nero Black finish Finition noire
50	89	92	OK0820020	509	409

Mensola per struttura - Shelf for structure - Tablette pour structure



* Per finiture mensola vedi pag. 154-155
* For shelf finishes see page 154-155
* Pour finitions tablette voir page 154-155

Prof. Depth cm	Larg. - Width - Long.	L. Consolle Vera	Codice - Code	EURO			
				Laccato Bianco White Lacquer Laqué blanc	* Lac. opaco Colorato Matt Col. Lacquer Laq. mate colorée	* Lac. lucido Colorato Glossy Col. Lacquer Lac. Couleur brillante	* Melaminico Melamine Mélamine
42	93	92	OK0830020	139	153	193	86

Piletta - Drain plug - Bonde



• Piletta a scarico libero con tappo in ceramica
• Free-flowing drain plug with ceramic cap
• Bonde de vidange libre avec bouchon en céramique

Kg 0,5

Codice - Code	EURO		
	Bianco lucido Glossy White Blanc brillant	Bianco opaco Matt White Blanc mat	Colorato opaco Matt Coloured Couleur mate
OK9920060	80		
	007	006	063 062 036



• Piletta pop-up Ø 4,5 cm
• Pop-up drain plug Ø 4,5 cm
• Bonde pop-up Ø 4,5 cm

Kg 0,5

Codice - Code	EURO			
	Cromo Chrome Chrome	Nero Black Noir	Rosa Pink Rose	Acciaio Steel Acier
OOPFP	31	53	94	101

Consolle Vera L 107

Lavabo 107x51 cm - Washbasin - Lavabo

107 x 51 x H 11 cm

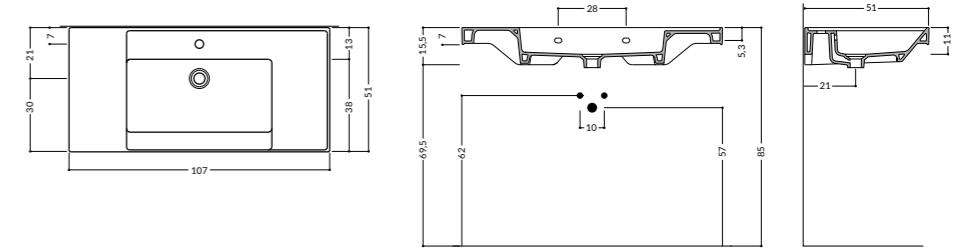

Consolle dimensione fissa, installazione a parete, da appoggio o con struttura, completa di fissaggi - Fixed size console, with structure, wall-hung or countertop installation, complete with fixings - Console de taille fixe, avec structure, installation au mur ou à poser, complète avec fixations

Kg 31,5

Codice - Code	EURO		
	Bianco lucido Glossy White Blanc brillant	Bianco opaco Matt White Blanc mat	Colorato opaco Matt Coloured Couleur mate
OK0810030	603	833	833
	007	006	063 062 036

Struttura a terra H 79 cm, completa di barra porta asciugamano

Ground-installed structure H 79 cm, complete with towel bar - Structure au sol H 79 cm, complet avec porte-serviettes



Prof. Depth cm	Larg. - Width - Long.	L. Consolle Vera	Codice - Code	EURO	
				Finitura acciaio Steel finish Finition acier	Finitura nero Black finish Finition noire
50	104	107	OK0820030	545	423

Mensola per struttura - Shelf for structure - Tablette pour structure



* Per finiture mensola vedi pag. 154-155
* For shelf finishes see page 154-155
* Pour finitions tablette voir page 154-155

Prof. Depth cm	Larg. - Width - Long.	L. Consolle Vera	Codice - Code	EURO			
				Laccato Bianco White Lacquer Laqué blanc	* Lac. opaco Colorato Matt Col. Lacquer Laq. mate colorée	* Lac. lucido Colorato Glossy Col. Lacquer Lac. Couleur brillante	* Melaminico Melamine Mélamine
42	108	107	OK0830030	156	171	216	95

Piletta - Drain plug - Bonde



• Piletta a scarico libero con tappo in ceramica
• Free-flowing drain plug with ceramic cap
• Bonde de vidange libre avec bouchon en céramique

Kg 0,5

Codice - Code	EURO		
	Bianco lucido Glossy White Blanc brillant	Bianco opaco Matt White Blanc mat	Colorato opaco Matt Coloured Couleur mate
OK9920060	80		
	007	006	063 062 036



• Piletta pop-up Ø 4,5 cm
• Pop-up drain plug Ø 4,5 cm
• Bonde pop-up Ø 4,5 cm

Kg 0,5

Codice - Code	EURO			
	Cromo Chrome Chrome	Nero Black Noir	Rosa Pink Rose	Acciaio Steel Acier
OOPFP	31	53	94	101

Consolle Vera L 122

Lavabo 122x51 cm - Washbasin - Lavabo
122 x 51 x H 11 cm

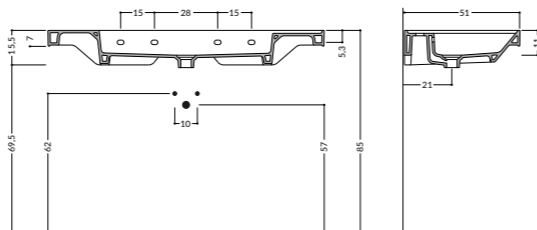
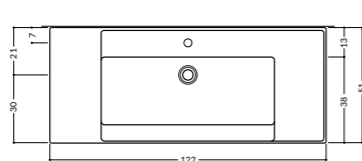

Consolle dimensione fissa, installazione a parete, da appoggio o con struttura, completa di fissaggi - Fixed size console, with structure, wall-hung or countertop installation, complete with fixings - Console de taille fixe, avec structure, installation au mur ou à poser, complète avec fixations

Kg 37,5

Codice - Code	EURO		
	Bianco lucido Glossy White Blanc brillant	Bianco opaco Matt White Blanc mat	Colorato opaco Matt Coloured Couleur mate
OK0810040	702	972	972
	007	006	063 062 036

Struttura a terra H 79 cm, completa di barra porta asciugamano

Ground-installed structure H 79 cm, complete with towel bar - Structure au sol H 79 cm, complet avec porte-serviettes



Prof. Depth cm	Larg. - Width - Long.	L. Consolle Vera	Codice - Code	EURO	
				Finitura acciaio Steel finish Finition acier	Finitura nero Black finish Finition noire
50	119	122	OK0820040	594	464

Mensola per struttura - Shelf for structure - Tablette pour structure



* Per finiture mensola vedi pag. 154-155
* For shelf finishes see page 154-155
* Pour finitions tablette voir page 154-155

Prof. Depth cm	Larg. - Width - Long.	L. Consolle Vera	Codice - Code	EURO			
				Laccato Bianco White Lacquer Laqué blanc	* Lac. opaco Colorato Matt Col. Lacquer Laq. mate colorée	* Lac. lucido Colorato Glossy Col. Lacquer Lac. Couleur brillante	* Melaminico Melamine Mélamine
42	123	122	OK0830040	172	189	239	104

Piletta - Drain plug - Bonde



• Piletta a scarico libero con tappo in ceramica
• Free-flowing drain plug with ceramic cap
• Bonde de vidange libre avec bouchon en céramique

Kg 0,5

Codice - Code	EURO		
	Bianco lucido Glossy White Blanc brillant	Bianco opaco Matt White Blanc mat	Colorato opaco Matt Coloured Couleur mate
OK9920060	80		
	007	006	063 062 036



• Piletta pop-up Ø 4,5 cm
• Pop-up drain plug Ø 4.5 cm
• Bonde pop-up Ø 4,5 cm

Kg 0,5

Codice - Code	EURO			
	Cromo Chrome Chrome	Nero Black Noir	Rosa Pink Rose	Acciaio Steel Acier
OOPFP	31	53	94	101

Consolle Vera L 142

Lavabo 142x51 cm - Washbasin - Lavabo
142 x 51 x H 11 cm

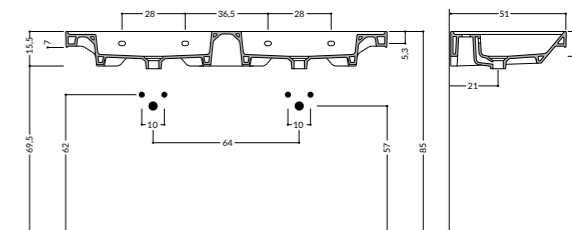
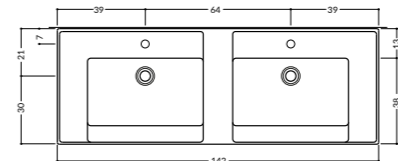

Consolle dimensione fissa, installazione a parete, da appoggio o con struttura, completa di fissaggi - Fixed size console, with structure, wall-hung or countertop installation, complete with fixings - Console de taille fixe, avec structure, installation au mur ou à poser, complète avec fixations

Kg 46,5

Codice - Code	EURO		
	Bianco lucido Glossy White Blanc brillant	Bianco opaco Matt White Blanc mat	Colorato opaco Matt Coloured Couleur mate
OK0810050	882	1.224	1.224
	007	006	063 062 036

Struttura a terra H 79 cm, completa di barra porta asciugamano

Ground-installed structure H 79 cm, complete with towel bar - Structure au sol H 79 cm, complet avec porte-serviettes



Prof. Depth cm	Larg. - Width - Long.	L. Consolle Vera	Codice - Code	EURO	
				Finitura acciaio Steel finish Finition acier	Finitura nero Black finish Finition noire
50	139	141	OK0820050	657	509

Mensola per struttura - Shelf for structure - Tablette pour structure



* Per finiture mensola vedi pag. 154-155
* For shelf finishes see page 154-155
* Pour finitions tablette voir page 154-155

Prof. Depth cm	Larg. - Width - Long.	L. Consolle Vera	Codice - Code	EURO			
				Laccato Bianco White Lacquer Laqué blanc	* Lac. opaco Colorato Matt Col. Lacquer Laq. mate colorée	* Lac. lucido Colorato Glossy Col. Lacquer Lac. Couleur brillante	* Melaminico Melamine Mélamine
42	143	142	OK0830050	193	212	266	117

Piletta - Drain plug - Bonde



• Piletta a scarico libero con tappo in ceramica
• Free-flowing drain plug with ceramic cap
• Bonde de vidange libre avec bouchon en céramique

Kg 0,5

Codice - Code	EURO		
	Bianco lucido Glossy White Blanc brillant	Bianco opaco Matt White Blanc mat	Colorato opaco Matt Coloured Couleur mate
OK9920060	80		
	007	006	063 062 036



• Piletta pop-up Ø 4,5 cm
• Pop-up drain plug Ø 4.5 cm
• Bonde pop-up Ø 4,5 cm

Kg 0,5

Codice - Code	EURO			
	Cromo Chrome Chrome	Nero Black Noir	Rosa Pink Rose	Acciaio Steel Acier
OOPFP	31	53	94	101

Espositore Sanitari

Sanitaryware display stand - Vitrine de présentation pour articles sanitaires

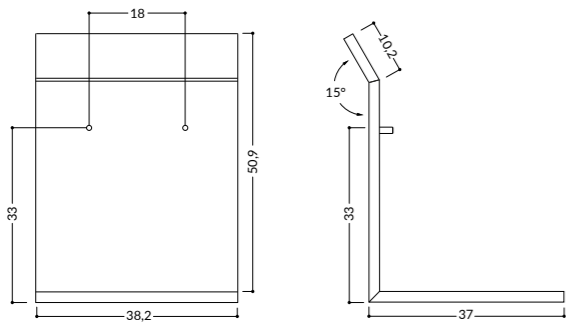

Elemento - Element - Élément	Descrizione - Description	Codice - Code	Modello - Model	EURO
	Espositore per modello AVIGO Staffa di supporto sanitario sospeso colore grigio Support bracket wall-hung sanitaryware grey colour Support au mur des appareils sanitaires, couleur grise	OK9920160	001	228
	Espositore per modello FIO Staffa di supporto sanitario sospeso colore grigio Support bracket wall-hung sanitaryware grey colour Support au mur des appareils sanitaires, couleur grise		002	228
	Espositore per modello STINO Staffa di supporto sanitario sospeso colore grigio Support bracket wall-hung sanitaryware grey colour Support au mur des appareils sanitaires, couleur grise		003	228
	Espositore per modello VOGA Staffa di supporto sanitario sospeso colore grigio Support bracket wall-hung sanitaryware grey colour Support au mur des appareils sanitaires, couleur grise		004	228

Accessori

Accessories

Rubinetteria per lavabi e bidet

Washbasin and bidet taps - Robinetterie pour lavabo et bidet

RULE A1	Descrizione - Description	Codice - Code	EURO															
			Cromo Chrome Chrome	Nero Black Noir	Rosa Pink Rose	Acciaio sat. Steel Acier												
	Mix LAVABO RULE con piletta di scarico RULE washbasin mix with drain plug Mix lavabo RULE avec bonde d'évacuation	00RUL1	129	-	-	-												
	Mix LAVABO RULE Medio (necessita di piletta Pop-up) RULE medium washbasin mix (Requires Pop-up drain plug) Mix lavabo RULE Moyen (nécessite de bonde Pop-up)	00RUL2	147	222	362	243												
	Mix LAVABO RULE Alto (necessita di piletta Pop-up) RULE high washbasin mix (Requires Pop-up drain plug) Mix lavabo RULE Haut (nécessite de bonde Pop-up)	00RUL3	219	315	461	352												
	Mix BIDET RULE necessita di piletta pop-up RULE bidet mix requires pop-up waste Mix Bidet RULE nécessite bonde de vidange	00RUL4	137	202	442	222												
	Mix RULE A PARETE (necessita di piletta Pop-up) Wall mounted RULE mix (Requires Pop-up drain plug) Mix RULE mural (nécessite de bonde Pop-up)	00RUL5	219	326	-	-												
	• Sifone • Siphon	00SFN01	87	181	265	181												
	• Piletta pop-up Ø 4,5 cm • Pop-up drain plug Ø 4.5 cm • Bonde pop-up Ø 4,5 cm Kg 0,5	00PFP	31	53	94	101												
	• Piletta a scarico libero con tappo in ceramica • Free-flowing drain plug with ceramic cap • Bonde de vidange libre avec bouchon en céramique Kg 0,5	OK9920060	<table border="1"> <thead> <tr> <th colspan="3">EURO</th> </tr> <tr> <th>Bianco lucido Glossy White Blanc brillant</th> <th>Bianco opaco Matt White Blanc mat</th> <th>Colorato opaco Matt Coloured Couleur mate</th> </tr> <tr> <th colspan="3">80</th> </tr> </thead> <tbody> <tr> <td>007</td> <td>006</td> <td>063 062 036</td> </tr> </tbody> </table>				EURO			Bianco lucido Glossy White Blanc brillant	Bianco opaco Matt White Blanc mat	Colorato opaco Matt Coloured Couleur mate	80			007	006	063 062 036
EURO																		
Bianco lucido Glossy White Blanc brillant	Bianco opaco Matt White Blanc mat	Colorato opaco Matt Coloured Couleur mate																
80																		
007	006	063 062 036																

Accessori

Accessories

Cassette di scarico HAFRO

HAFRO toilet cisterns - Réservoir de toilette HAFRO



Elemento - Element - Élément	Descrizione - Description	Codice - Code	EURO
<p>6/3 lt Volume scarico: (pregolato) Flush volume: (pre-adjusted) Volume d'écoulement: (préréglé)</p>	<p>Cassetta di scarico ad incasso per VASI A TERRA (per pareti in muratura e pareti leggere / cartongesso) - In-wall flush cistern for GROUND-INSTALLED WCs (for lightweight walls / plasterboard) - Réservoir de chasse à encastrer pour WC AU SOL (pour murs légers / placoplâtre)</p>	OK9920010	285
<p>6/3 lt Volume scarico: (pregolato) Flush volume: (pre-adjusted) Volume d'écoulement: (préréglé)</p>	<p>Cassetta di scarico ad incasso per VASI SOSPESI (per pareti in muratura) - In-wall flush cistern for WALL-HUNG WCs (for masonry walls) - Réservoir de chasse à encastrer pour WC SUSPENDUS (pour murs en maçonnerie)</p>	OK9920020	416
<p>6/3 lt Volume scarico: (pregolato) Flush volume: (pre-adjusted) Volume d'écoulement: (préréglé)</p>	<p>Cassetta di scarico ad incasso per VASI SOSPESI (per pareti leggere / cartongesso) - In-wall flush cistern for WALL-HUNG WCs (for lightweight walls / plasterboard) - Réservoir de chasse à encastrer pour WC SUSPENDUS (pour murs légers / placoplâtre)</p>	OK9920030	563

Accessori

Accessories

Placca di comando

Flush plate - Plaque de commande WC

Elemento - Element - Élément	Descrizione - Description	Codice - Code	Finitura - Finish - Finir	EURO
	<p>Placca di comando A - BIANCO OPACO A Flush plate - MATT WHITE Plaque de commande A - BLANC MAT</p>	OK9920040	006 Bianco opaco Matt white Blanc mat	80
	<p>Placca di comando A - BIANCO LUCIDO A Flush plate - POLISHED WHITE Plaque de commande A - BLANC BRILLANT</p>		007 Bianco lucido Polished white Blanc brillant	80
	<p>Placca di comando A - NERO OPACO A Flush plate - MATT BLACK Plaque de commande A - NOIR MAT</p>		036 Nero opaco Matt black Noir mat	80
	<p>Placca di comando B - BIANCO B Flush plate - WHITE Plaque de commande B - BLANC</p>	OK9920120	004 Bianco White Blanc	80
	<p>Placca di comando B - CROMO LUCIDO B Flush plate - POLISHED CHROME Plaque de commande B - CHROME BRILLANT</p>		002 Cromo lucido Polished chrome Chrome brillant	150





Accessori

Accessories

Elemento - Element - Élément	Descrizione - Description	Codice - Code	EURO
	<p>Curva tecnica STANDARD STANDARD pan connector Connecteur STANDARD</p>	OK9920070	15
	<p>Curva tecnica "S" tagliabile a misura Cutable pan connector "S" type Connecteur "S" coupée sur mesure</p>	OK9920080	28
	<p>Curva tecnica "L" tagliabile a misura Cutable pan connector "L" type Connecteur "L" coupée sur mesure</p>	OK9920090	28







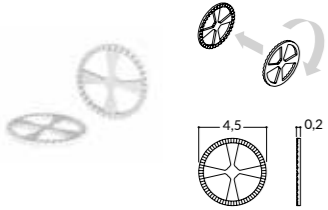

Accessori

Accessories

Elemento - Element - Élément	Descrizione - Description	Codice - Code	EURO
	<p>Protezione acustica per vaso sospeso e bidet Acoustic protection for wall-hung WC and bidet Protection acoustique pour WC et bidet suspendus</p>	OK9920110	36
	<p>Raccordo adduzione acqua WC water connector Raccord d'adduction d'eau</p>	OK9920130	8
	<p>Raccordo eccentrico 10 mm per adduzione acqua Eccentric connector 10 mm for water supply Raccord excentrique 10 mm pour alimentation d'eau</p>	OK9920140	8
	<p>Staffa universale adatta per wc e bidet su muratura Universal bracket suitable for wall-hung WC and bidet Support universel pour wc et bidet suspendus</p> <p>fischer </p>	OK9910040	56

Ricambi

Spare parts - Pièces détachées

Elemento - Element - Élément	Descrizione - Description	Codice - Code	EURO
	<p>Riduttore di flusso regolabile per adduzione WC, a seconda del posizionamento aumenta o riduce il flusso d'acqua.</p> <p>Adjustable flow reducer for WC supply, depending on the placement it increases or decreases water flow.</p> <p>Reducteur de debit réglable pour adduction WC, selon le positionnement, augmente ou diminue le débit d'eau.</p>	OK9920150	7
	<p>Kit fissaggio nascosto WB7 - wc e bidet a terra</p> <p>Hidden fixing kit WB7 - ground-installed wc and bidet</p> <p>Kit de fixation invisible WB7 - wc et bidet au sol</p> <p>fischer </p>	OK9910010	19
	<p>Kit fissaggio rapido WB9 - wc e bidet sospesi</p> <p>Rapid fixing kit WB9 - wall-hung WC and bidet</p> <p>Kit de fixation rapide WB9 - WC et bidet suspendus</p> <p>fischer </p>	OK9910020	24
	<p>WB-KLIX - Sistema di fissaggio sanitari - Voga sospesi</p> <p>WB-KLIX - Sanitary Fixing System - Voga suspended</p> <p>WB-KLIX - Système de fixation sanitaire - Voga suspendu</p> <p>fischer </p>	OK9910030	35
	<p>Kit fissaggio WST-KLIK per consolle Vera e lavabo Arko</p> <p>WST-KLIK fixing kit for Vera console and Arko washbasin</p> <p>Kit de fixation WST-KLIK pour console Vera et lavabo Arko</p> <p>fischer </p>	OK9910050	10

HAFRO
WELLNESS & SHOWER

Le nuove vasche

The new tubs - Les nouvelles baignoires

Avigo Fio



Avigo vasca

Vasca in mineraltek bianco lucido o bianco opaco
Glossy and Matt white mineraltek bathtub
Baignoire mineraltek blanc brillant ou mat

170 x 75 x 58 H cm



Fio vasca

Vasca in mineraltek bianco lucido o bianco opaco
Glossy and Matt white mineraltek bathtub
Baignoire mineraltek blanc brillant ou mat

Ø 125 x 58 H cm



Avigo vasca

Vasca in mineraltek bianco lucido o bianco opaco

Glossy matt white mineraltek bathtub - Baignoire mineraltek blanc brillant ou mat

INSTALLAZIONE CENTRO STANZA - CENTRE ROOM INSTALLATION - INSTALLATION EN ILOT



170 x 75 x 58 H cm

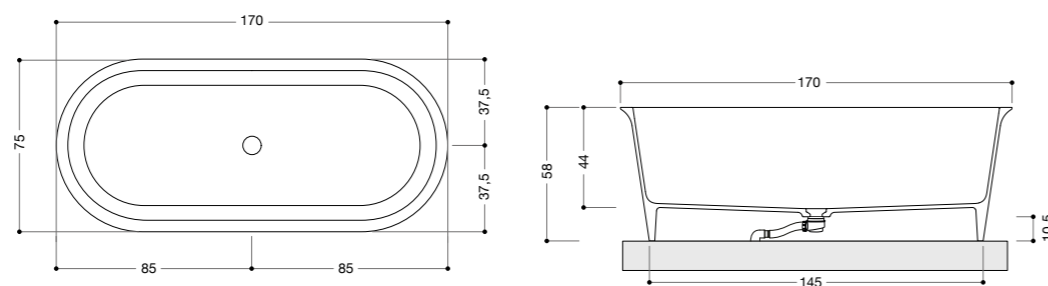

Descrizione - Description

- Colonna di scarico integrata nella vasca · Piletta pop-up con tappo in finitura · Sifone scarico in plastica
- Drain column integrated in the tub · Pop-up drain with plug in finish · Plastic drain siphon
- Colonne de vidage intégrée dans la baignoire · Pop-up vidage avec bonde en meme finition · Siphon de drainage en plastique

Peso 129 Kg
210 lt circa di utilizzo

Weight 129 kg
Approx. 210 litres of use

Poids 129 kg
Approx. 210 litres d'utilisation





Maggiorazione BICOLOR opaco (solo esterno) : + 1.058

BICOLOR Surcharge Matt Finish (external only) - Supplément BICOLORE Finition Mat (Externe uniquement)

Per finiture bicolor vedi pag.155
For bicolor finishes see page 155
Pour finitions bicolore voir page 155

Valori espressi in cm. Per maggiori informazioni fare riferimento alla scheda tecnica.
Values expressed in cm. For more information refer to the technical data sheet. - Valeurs exprimées en cm. Pour plus d'informations, reportez-vous à la fiche technique.

RUBINETTERIA - TAPS - ROBINETTERIE

Accessori - Accessories	Codice - Code	Finishes	EURO	Accessori - Accessories	Codice - Code	Finishes	EURO
 <p>Rubinetteria a piantana quadra con bocca erogazione e mix Squared shape floor standing tap with water filling spout and mix Robinetterie sur pied carrée avec bec de remplissage et mitigeur</p>	ORBH4NO	CR Cromo Chrome Chrome	1.247	 <p>Rubinetteria a piantana tonda con bocca erogazione e mix Rounded shape floor standing tap with water filling spout and mix Robinetterie sur pied ronde et mitigeur avec bec de remplissage</p>	ORBH5NO	CR Cromo Chrome Chrome	953
		NO Nero opaco Matt black Noir mat	1.565			NO Nero opaco Matt black Noir mat	1.272

Fio vasca

Vasca in mineraltek bianco lucido o bianco opaco

Glossy matt white mineraltek bathtub - Baignoire mineraltek blanc brillant ou mat

INSTALLAZIONE CENTRO STANZA - CENTRE ROOM INSTALLATION - INSTALLATION EN ILOT



Ø 125 x 58 H cm

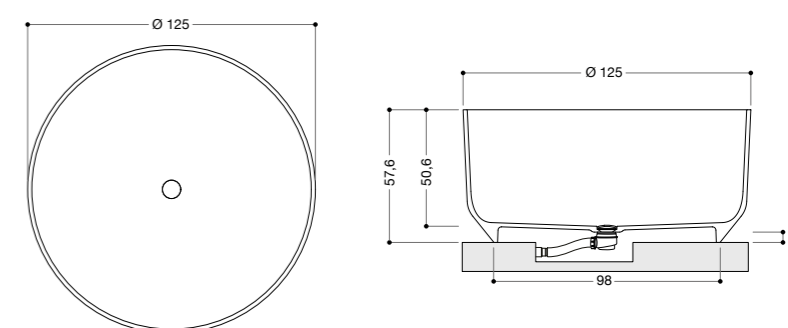

Descrizione - Description

- Colonna di scarico integrata nella vasca · Piletta pop-up con tappo in finitura · Sifone scarico in plastica
- Drain column integrated in the tub · Pop-up drain with plug in finish · Plastic drain siphon
- Colonne de vidage intégrée dans la baignoire · Pop-up vidage avec bonde en meme finition · Siphon de drainage en plastique

Peso 118 Kg
370 lt circa di utilizzo

Weight 118 kg
Approx. 370 litres of use

Poids 118 kg
Approx. 370 litres d'utilisation





Maggiorazione BICOLOR opaco (solo esterno) : + 1.058

BICOLOR Surcharge Matt Finish (external only) - Supplément BICOLORE Finition Mat (Externe uniquement)

Per finiture bicolor vedi pag.155
For bicolor finishes see page 155
Pour finitions bicolore voir page 155

Valori espressi in cm. Per maggiori informazioni fare riferimento alla scheda tecnica.
Values expressed in cm. For more information refer to the technical data sheet. - Valeurs exprimées en cm. Pour plus d'informations, reportez-vous à la fiche technique.

RUBINETTERIA - TAPS - ROBINETTERIE

Accessori - Accessories	Codice - Code	Finishes	EURO	Accessori - Accessories	Codice - Code	Finishes	EURO
 <p>Rubinetteria a piantana quadra con bocca erogazione e mix Squared shape floor standing tap with water filling spout and mix Robinetterie sur pied carrée avec bec de remplissage et mitigeur</p>	ORBH4NO	CR Cromo Chrome Chrome	1.247	 <p>Rubinetteria a piantana tonda con bocca erogazione e mix Rounded shape floor standing tap with water filling spout and mix Robinetterie sur pied ronde et mitigeur avec bec de remplissage</p>	ORBH5NO	CR Cromo Chrome Chrome	953
		NO Nero opaco Matt black Noir mat	1.565			NO Nero opaco Matt black Noir mat	1.272

MELAMINICI PER MENSOLA CONSOLLE VERA

Melamine for Vera Consolle - Mèlaminés pour Console Vera

SABLÈ



SB1
Sablè Naturale
Natural Sablè
Sablè Naturel



SB2
Sablè Bianco
White Sablè
Sablè Blanc



SB3
Sablè Grigio
Grey Sablè
Sablè Gris

MILLENNIUM



M1
Millennium bianco
White Millennium
Millennium blanc

ENGADINA



EN1
Engadina grigio chiaro
Light Grey Engadina
Engadina gris clair

SHERWOOD



SH1
Sherwood miele
Honey Sherwood
Sherwood miel



SH2
Sherwood tabacco
Tobacco Sherwood
Sherwood tabac

ARES



RS1
Ares Bianco
White Ares
Arès Blanc



RS2
Ares Grigio
Grey Ares
Arès Gris



RS3
Ares Visone
Mink Ares
Arès Vison



RS4
Ares Grafite
Graphite Ares
Arès Graphite

LACCATI LUCIDI E OPACHI PER CONSOLLE VERA

Matt and glossy lacquer colours for Vera Consolle - Couleurs laquées brillantes et mates pour Console Vera

A / Opaco - Matt - Mat

B / Lucido - Glossy - Brillant

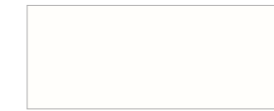

A01
Bianco
White
Blanc

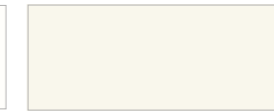

B01
Bianco
White
Blanc



A17
Ghiaccio
Ice
Glacé



B17
Ghiaccio
Ice
Glacé



A26
Cashmere

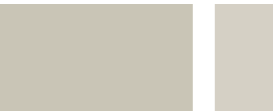

B26
Cashmere



A20
Grigio Efeso
Efesus Grey
Gris Efesus



B20
Grigio Efeso
Efesus Grey
Gris Efesus



A41
Aria
Air

B41
Aria
Air



A22
Grigio Bromo
Bromo Grey
Gris Bromo

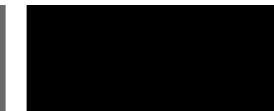

B22
Grigio Bromo
Bromo Grey
Gris Bromo



A15
Nero
Black
Noir



B15
Nero
Black
Noir



A25
Grigio Cosmico
Cosmic Grey
Gris Cosmique



B25
Grigio Cosmico
Cosmic Grey
Gris Cosmique



A24
Grigio Londra
London Grey
Gris Londres



B24
Grigio Londra
London Grey
Gris Londres



A43
Fango
Mud
Boue

B43
Fango
Mud
Boue



A42
Sabbia
Sand
Sable



B42
Sabbia
Sand
Sable



A45
Ecrù



B45
Ecrù



A44
Paglia
Straw
Paille



B44
Paglia
Straw
Paille



A49
Girasole
Sunflower
Tournesol



B49
Girasole
Sunflower
Tournesol



A47
Safari

B47
Safari



A46
Mattone
Brick red
Rouge brique



B46
Mattone
Brick red
Rouge brique



A48
Bordeaux



B48
Bordeaux



A50
Dolomite

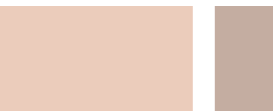

B50
Dolomite



A51
Rosa Antico
Antique pink
Rose Antique



B51
Rosa Antico
Antique pink
Rose Antique



A52
Glicine
Glycine

B52
Glicine
Glycine



A53
Blu Notte
Midnight blue
Bleu nuit



B53
Blu Notte
Midnight blue
Bleu nuit



A54
Colibri



B54
Colibri



A55
Agave



B55
Agave



A56
Carta da Zucchero
Sugar paper
Papier de sucre



B56
Carta da Zuc.
Sugar paper
Papier de sucre



A37
Salvia
Sage
Salvus

B37
Salvia
Sage
Salvus



A57
Baltico
Baltic



B57
Baltico
Baltic



A59
Laguna
Lagoon
Lagune



B59
Laguna
Lagoon
Lagune



A58
Artico
Arctic
Arctique



B58
Artico
Arctic
Arctique

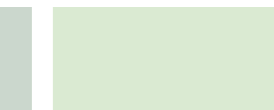

A39
Menta
Mint



B39
Menta
Mint

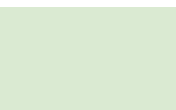

A62
Aloe

B62
Aloe



A61
Mare
Sea
Mer



B61
Mare
Sea
Mer



A60
Pino
Pine
Pin



B60
Pino
Pine
Pin



A63
Verde Bosco
Forest green
Foret vert



B63
Verde Bosco
Forest green
Foret vert



A64
Giungla
Jungle



B64
Giungla
Jungle



A38
Timo
Thyme

B38
Timo
Thyme



A65
Palude
Swamp
Maracage



B65
Palude
Swamp
Maracage



A67
Foglia
Leaf
Feuille



B67
Foglia
Leaf
Feuille



A66
Bamboo
Bambou



B66
Bamboo
Bambou

I CONSIGLI DI HAFRO PER UNA CORRETTA PULIZIA

Pulizia della ceramica

Lavare le superfici delle ceramiche esclusivamente con acqua tiepida e prodotti neutri liquidi. Per risciacquare e asciugare usare spugne panni morbidi, no spugne abrasive.

Pulizia dei sedili e delle cerniere

Si consiglia di pulire i sedili e le cerniere utilizzando solamente spugne o panni morbidi con acqua e sapone neutro.

In fase di pulizia delle ceramiche con prodotti ad effetto prolungato, evitare il contatto con il coprivaso e le sue componenti metalliche.

In fase di pulizia delle ceramiche con prodotti anticalcare, non tenere abbassato il sedile, per evitare l'esposizione a vapori che potrebbero alterarne la brillantezza. I sedili in versione colorata sono più delicati e soggetti a cambiamenti di colore, anche se minimamente esposti ai vapori.

Utilizzare prodotti errati può provocare ossidazione o arrugginimento delle cerniere, anche dopo un tempo ridotto.

HAFRO'S TIPS FOR PROPER CLEANING

Ceramics cleaning

Wash ceramic surfaces only with lukewarm water and neutral liquid products. Use soft sponges for rinsing and drying, no abrasive sponges.

Seats and hinges cleaning

We recommend to clean seats and hinges only with sponges or soft cloths with mild soap and water.

When cleaning ceramics with products with a prolonged effect, avoid contact with cover and its metal components.

When cleaning ceramics with anti-limescale products, do not keep the seat down, to avoid exposure to vapours that could alter the brilliance.

Coloured seats are more delicate and subject to colour changes, even if minimally exposed to vapours. Using the wrong products can cause oxidation or rusting of hinges, even after a short time.

CONSEILS DE HAFRO POUR UN BON NETTOYAGE

Nettoyage de la céramique

Laver les surfaces en céramique uniquement avec de l'eau tiède et des produits liquides neutres. Utiliser des éponges douces pour le rinçage et le séchage, pas d'éponges abrasives.

Nettoyage des sièges et des charnières

Il est recommandé de nettoyer les sièges et les charnières à l'aide d'éponges ou de chiffons doux avec de l'eau et du savon doux.

Lorsque le nettoyage de la céramique est effectué avec des produits à effet prolongé, évitez tout contact avec le siège et ses composants métalliques.

Lorsque le nettoyage de la céramique est effectué avec des produits anticalcaires, ne pas laisser le siège abaissé afin d'éviter l'exposition à des vapeurs qui pourraient altérer la brillante. Les sièges colorés sont plus délicats et susceptibles de changer de couleur, même lorsqu'ils sont très peu exposés aux vapeurs. L'utilisation de produits inadaptés peut entraîner l'oxydation ou la rouille des charnières, même après un court laps de temps.

CONDIZIONI GENERALI DI VENDITA

1. ORDINI: Qualsiasi ordine è impegnativo per il committente; lo diventa per Gruppo Geromin Srl solo a seguito di specifica conferma scritta.

2. ANNULLAMENTO ORDINI: L'annullamento di un ordine implica l'accettazione scritta da parte di Gruppo Geromin Srl. Gruppo Geromin Srl si riserva la facoltà di addebitare al committente tutti gli oneri conseguenti.

3. TEMPI DI CONSEGNA: I tempi di consegna devono esser considerati puramente indicativi; in caso di ritardo non è riconosciuto alcun indennizzo. La consegna dell'ordine si intende evasa all'atto della presa in carico del prodotto, presso il magazzino Gruppo Geromin Srl, da parte del vettore incaricato del trasporto.

4. PAGAMENTI: Le condizioni di pagamento, se non diversamente indicate in fattura, sono le seguenti:
- vendite nazionali: 30 gg df, in presenza di una linea di credito accordata; diversamente, pagamento anticipato all'atto della consegna;
- vendite export: lettera di credito irrevocabile confermata da primario istituto di credito italiano.

I prodotti forniti rimangono di proprietà di Gruppo Geromin Srl fino all'avvenuto completo pagamento in conformità agli art. 1523 e seguenti del Codice Civile.

5. DANNI DA TRASPORTO: Il cliente che riceve un prodotto danneggiato durante il trasporto deve firmare la bolla di consegna con riserva di controllo, specificando la tipologia di danno riscontrato e comunicare a Gruppo Geromin Srl, entro il termine di 8 giorni, a mezzo lettera mail o lettera raccomandata, il danno rilevato.

6. RESI: I resi devono essere espressamente autorizzati da Gruppo Geromin Srl. In ogni caso restano a carico del committente gli oneri relativi al trasporto, nonché i costi amministrativi quantificati nella cifra minima del 25% del valore di fatturazione. Non si accettano resi riguardanti prodotti realizzati su specifica richiesta.

7. GARANZIA: I prodotti in ceramica del catalistino “Ceramiche di Hafro” hanno una garanzia di 10 anni a decorrere dalla data di consegna. Il resto dei prodotti presentano una garanzia di 24 mesi. In caso di reclamo è richiesta la prova di acquisto. Gruppo Geromin Srl garantisce la qualità del prodotto e si impegna a sostituire eventuali pezzi difettosi; qualsiasi difetto deve comunque essere segnalato prima dell'installazione. Il prodotto deve essere installato, utilizzato e mantenuto con cura e secondo le istruzioni di installazione annesse. La presente garanzia non è valida in caso di usura generale o nel caso in cui venga giudicato da Gruppo Geromin Srl accidentalmente danneggiato, erroneamente utilizzato o oggetto di cattiva pulizia/manutenzione. La garanzia non è trasferibile nel caso in cui il prodotto venga reinstallato in una diversa posizione.

8. PREZZI: I prezzi del presente listino sono Iva esclusa e per merce resa franco fabbrica. L'installazione dei prodotti è sempre esclusa e deve avvenire a cura dell'utilizzatore finale. Gruppo Geromin Srl si riserva la facoltà di variare i prezzi di listino senza obbligo di preavviso.

9. RESPONSABILITÀ PER EVENTUALI DANNI: In presenza di eventuali danni causati da difettosità di prodotto, Gruppo Geromin Srl se ne farà carico nella misura prevista dalla legislazione vigente.

10. TOLLERANZE E COLORI: Le dimensioni e i pesi riportati nel presente listino si intendono indicativi. Gli articoli prodotti possono essere modificati o eliminati in qualsiasi momento senza preavviso.

Sono possibili tollerabili variazioni di colore dovute alla produzione, da considerare caratteristiche del prodotto e pertanto concesse. Gruppo Geromin Srl declina ogni responsabilità per divergenze di colore con prodotti di altri produttori o realizzati in altri materiali. I colori riportati nel catalistino e sul sito web potrebbero presentare lievi differenze rispetto al colore reale degli articoli in ceramica.

11. COPYRIGHT: I prodotti ceramici di Gruppo Geromin Srl sono distribuiti e disponibili per l'acquisto solo ed esclusivamente tramite la rete di rivenditori e distributori autorizzati. Le immagini relative ai prodotti di Gruppo Geromin Srl costituiscono parte integrante della proprietà. Qualsiasi utilizzo di dette immagini può essere autorizzato esclusivamente dietro concessione scritta da parte di Gruppo Geromin Srl.

12. FORO COMPETENTE: Per qualsiasi controversia è esclusivamente competente il foro di Venezia.

CONDIZIONI DI VENDITA IN “E-COMMERCE”

- I prodotti in ceramica del catalistino “Ceramiche di Hafro” potranno essere posti in vendita con uno sconto massimo del 30% dal listino in vigore, esclusa IVA, trasporti e costi accessori;
- Le spese di trasporto, IVA e ulteriori costi accessori, dovranno essere separati dal prezzo del prodotto offerto, in modo tale da rendere trasparente il prezzo di vendita;
- È severamente vietato l'utilizzo di sistemi di “asta a ribasso”;
- Potranno essere usate solo immagini ufficiali provenienti dal catalogo. L'uso di altre immagini dovrà essere autorizzato da Gruppo Geromin Srl.

Le foto sono puramente dimostrative. Riferirsi alle schede tecniche per dettagli tecnici. Gruppo Geromin Srl si riserva il diritto di apportare modifiche al prodotto in qualsiasi momento senza darne alcun preavviso.

GENERAL TERMS AND CONDITIONS OF SALE

1. **ORDERS:** All orders are binding for the customer. Orders become binding for Gruppo Geromin Srl only after written confirmation.
2. **CANCELLATION:** Cancellation of an order requires written approval from Gruppo Geromin Srl. Gruppo Geromin Srl reserves the right to charge the customer for all consequential costs.
3. **DELIVERY:** All delivery dates are purely indicative. No compensation will be due in the event of any delays. The shipping of the order is considered delivered as soon as the courier collects the products from Gruppo Geromin Srl warehouse.
4. **PAYMENT:** Unless otherwise stated on the invoice, the payment terms are as follows:
 - sales in Italy: payment due within 30 days of the invoice date where there is an approved credit line; otherwise, payment due upon delivery
 - international sales: irrevocable letter of credit confirmed by a major Italian bank.
 All products remain the property of Gruppo Geromin S.r.l. until payment has been made in compliance with articles 1523 et seq. of the Italian Civil Code.
5. **DAMAGE DURING TRANSPORTATION:** Customers who receive a product that has been damaged during transporting must sign the delivery note subject to checking, specifying the type of damage found, and notify Gruppo Geromin Srl within 8 days, by e-mail or registered letter, of the damage found.
6. **RETURNS:** Returns must be expressly authorised by Gruppo Geromin S.r.l. In all cases, all resulting transportation costs and administration fees (minimum 25% of the invoice amount) will be charged to the customer to 25% of the invoice value. Custom-made products are non-returnable.
7. **WARRANTY:** Ceramic products in the “Hafro Ceramics” catalogue have a 10-year guarantee from the delivery date. The other products have a 24-month warranty. Proof of purchase is required in the event of claims. Gruppo Geromin Srl guarantees the quality of the product and undertakes to replace any eventual defective parts; any defect must in any case be reported before installation. The product must be installed, used and maintained with care and according to the enclosed installation instructions. This warranty is not valid in the event of general wear or in case it is judged by Gruppo Geromin Srl to have been accidentally damaged, misused or subjected to bad cleaning/maintenance. The guarantee is not transferable if the product is reinstalled in a different position.
8. **PRICES:** List prices exclude VAT and are for products shipped Ex Works. Product installation is excluded and must be carried out by the end user. Gruppo Geromin S.r.l. reserves the right to modify list prices without prior notice.
9. **LIABILITY FOR DAMAGE:** In the event of any damage caused by a defective product, Gruppo Geromin S.r.l. will be held liable to the extent applicable under the laws in force.
10. **TOLERANCES AND COLOURS:** The dimensions and weights given in this price list are approximate. Articles produced may be changed or discontinued at any time without notice. Tolerable colour variations due to production are possible and should be considered as product characteristics and therefore allowed. Gruppo Geromin Srl declines all responsibility for differences in colour with products of other manufacturers or made of other materials. The colours shown in the catalogue and on the website may differ slightly from the actual colour of the ceramic articles.
11. **COPYRIGHT:** Ceramic products of Gruppo Geromin Srl are distributed and available for purchase only and exclusively through the network of authorised dealers and distributors. The images relating to the products of Gruppo Geromin Srl represent an integral part of the property. Any use of these images can only be authorised with the written permission of Gruppo Geromin Srl.
12. **COURT OF JURISDICTION:** Any disputes will be settled by the Court of Venice.

TERMS AND CONDITIONS OF SALE IN “E-COMMERCE”

1. Ceramic products in the ‘Hafro Ceramics’ catalogue may be sold at a maximum discount of 30% from the current price list, excluding VAT, transport and ancillary costs;
2. Transport costs, VAT and other ancillary costs shall be separated from the price of the product offered, so as to make the selling price transparent;
3. The use of ‘price auction’ systems is strictly prohibited;
4. Only official images from the catalogue can be used. The use of other images must be authorised by Gruppo Geromin Srl.

Images are purely illustrative. Please refer to the technical datasheets for all technical specifications. Gruppo Geromin S.r.l. reserves the right to modify its products at any time without prior notice.

CONDITIONS GÉNÉRALES DE VENTE

1. **COMMANDES:** Toute commande passée par le client est ferme et définitive; elle le devient pour Gruppo Geromin Srl uniquement après confirmation écrite.
2. **ANNULLATION DES COMMANDES:** L'annulation d'une commande implique l'approbation écrite de la part de Gruppo Geromin Srl. Gruppo Geromin Srl se réserve le droit de facturer au client le remboursement des frais inhérents.
3. **DÉLAIS DE LIVRAISON:** Les délais de livraison doivent être considérés à titre purement indicatif; en cas de retard, aucune indemnisation ne sera accordée. La livraison de la commande sera considérée évasée dès la prise en charge de la marchandise auprès de l'entrepôt Gruppo Geromin Srl, de la part du transporteur chargé du transport.
4. **PAIEMENTS:** Les conditions de paiement, sauf indication contraire mentionnée sur la facture, sont les suivantes:
 - ventes nationales: 30 jours à partir de la date d'émission de la facture, en présence d'une ligne de crédit accordée; autrement, paiement anticipé au moment de la livraison;
 - ventes à l'étranger: lettre de crédit irrévocable confirmée par une banque italienne de première importance.
 Les produits livrés restent de la propriété de la société Gruppo Geromin srl jusqu'à la fin du paiement du prix, conformément aux articles 1523 et suivants du Code civil.

5. **DOMMAGES DE TRANSPORT:** Le client qui reçoit un produit endommagé pendant le transport doit signer le bon de livraison soumis à vérification, en précisant le type de dommage constaté et notifier à Gruppo Geromin Srl dans les 8 jours, par e-mail ou par lettre recommandée, les dommages constatés.

6. **RETOURS:** Les retours de marchandise doivent être exclusivement autorisés par Gruppo Geromin srl, Dans tous les cas, les frais de transport et les éventuelles charges administratives restent toutefois à la charge du client, quantifiés par le montant minimum de 25% de la valeur de la facture. Les retours concernant les produits réalisés sur demande spécifique ne sont pas acceptés.

7. **GARANTIE:** Les produits en céramique du catalogue “Hafro Ceramics” bénéficient d'une garantie de 10 ans à compter de la date de livraison. Les autres produits bénéficient d'une garantie de 24 mois. Une preuve d'achat est exigée en cas de réclamation. Gruppo Geromin Srl garantit la qualité du produit et s'engage à remplacer les parties défectueuses; les défauts éventuels doivent toutefois être signalés avant l'installation. Le produit doit être installé, utilisé et entretenu avec soin et conformément aux instructions d'installation jointes. La garantie n'est pas valable en cas d'usure générale ou si Gruppo Geromin Srl estime que le produit a été accidentellement endommagé, mal utilisé ou soumis à un mauvais nettoyage/entretien. La garantie n'est pas transférable si le produit est réinstallé dans une position différente.

8. **PRIX:** Les prix de cette liste sont hors TVA et pour des marchandises départ usine. L'installation des produits est toujours exclue et doit être effectuée par l'utilisateur final. Gruppo Geromin srl se réserve le droit de modifier les prix de la liste sans obligation de préavis.

9. **RESPONSABILITÉS POUR ÉVENTUELS DOMMAGES:** En présence d'éventuels dommages causés par des défauts de fabrication, Gruppo Geromin srl est retenue responsable selon les termes prévus par la réglementation en vigueur.

10. **TOLÉRANCES ET COULEURS:** Les dimensions et les poids indiqués dans le présent tarif sont approximatifs. Les articles produits peuvent être modifiés ou retirés du marché à tout moment et sans préavis. Des variations de couleur tolérables dues à la production sont possibles et doivent être considérées comme des caractéristiques du produit et donc autorisées. Gruppo Geromin Srl décline toute responsabilité pour les différences de couleur avec des produits d'autres fabricants ou réalisés dans d'autres matériaux. Les couleurs indiquées dans le catalogue et sur le site Internet peuvent être légèrement différentes de la couleur réelle des articles en céramique.

11. **COPYRIGHT:** Les produits céramiques de Gruppo Geromin Srl sont distribués et disponibles à l'achat uniquement et exclusivement à travers le réseau de revendeurs et de distributeurs agréés. Les images relatives aux produits de Gruppo Geromin Srl font partie intégrante de la propriété. Toute utilisation de ces images ne peut être autorisée qu'avec la permission écrite de Gruppo Geromin Srl.

12. **TRIBUNAL COMPÉTENT:** Le tribunal défini comme compétent pour régler tout litige est celui de Venice.

CONDITIONS GÉNÉRALES DE VENTE DU COMMERCE ELECTRONIQUE

1. Les produits céramiques du catalogue “Hafro Ceramics” peuvent être proposés à la vente avec une remise maximale de 30 % par rapport au tarif en vigueur, hors TVA, transport et frais annexes;
2. Les frais de transport, la TVA et les autres frais accessoires sont séparés du prix du produit offert, de manière à ce que le prix de vente soit transparent;
3. L'utilisation de systèmes de “vente aux enchères” est strictement interdite;
4. Seules les images officielles du catalogue peuvent être utilisées. L'utilisation d'autres images doit être autorisée par Gruppo Geromin Srl.

Les photos sont à titre purement indicatif. Se référer aux fiches techniques pour les détails techniques. Gruppo Geromin srl se réserve le droit de modifier le produit à tout moment et sans préavis.

Design & Coordination
Gruppo Geromin

Art direction Graphic Design
Lokomotiv

Photo & Rendering
Indoor

Colour separation
Luce

Print
AGCM

September 2023

Scopri le nostre collezioni
Discover our collections
Découvrez nos collections





GRUPPO GEROMIN
VENEZIA 1945

HAFRO | SAUNAVITA | GEROMIN

GRUPPO GEROMIN Srl
Via 1° Maggio, 5 - 30029 San Stino di Livenza VE-I
TEL +39 0421 312 249
info@gruppogeromin.com www.gruppogeromin.com